

# powercoil<sup>®</sup>

wire thread insert system





	Free Running Insert Frei laufender Einsatz Filet rapporté standard Inserto standard 普通型螺套 フリーランニングインサート		8-UN Constant Pitch 8-UN konstante Steigung Pas constant 8-UN Rosca Americana paso 8 hilos 英制 8 螺紋 8-UN 一定ピッチ		MC, MF, UNC, UNF, 8 Pitch, NPT – HSS <b>Bottoming</b> STI Tap MC, MF, UNC, UNF, 8 Steigungs-, NPT – HSS <b>vorschneider</b> STI-Gewindeschneider Taraud STI <b>finisseur</b> MC, MF, UNC, UNF, 8 pas, NPT – HSS Macho STI de acabado, Nº 3 – MC, MF, UNC, UNF, 8 UN, NPT 高速鋼螺套專用絲錐 (底錐) 適用於 MC, MF, UNC, UNF, 8 UN, NPT 螺紋 MC, MF, UNC, UNF, 8 Pitch, NPT - HSS STI 先打タップ
	Screw Locking Insert Screwlockender Einsatz Filet rapporté à frein de vis Inserto autofrenante 鎖緊型螺套 ロックタイプインサート		British Association British Association Association britannique Rosca inglesa BA BA 螺紋 英国協会		MC, MF, UNC, UNF, 8 Pitch, NPT – HSS <b>Intermediate</b> STI Tap MC, MF, UNC, UNF, 8 Steigungs-, NPT – HSS <b>Einschnitt</b> STI - Gewindeschneider Taraud STI <b>intermédiaire</b> MC, MF, UNC, UNF, 8 pas, NPT – HSS Macho STI intermedio, Nº 3 – MC, MF, UNC, UNF, 8 UN, NPT 高速鋼螺套專用絲錐 (中錐) 適用於 MC, MF, UNC, UNF, 8 UN, NPT 螺紋 MC, MF, UNC, UNF, 8 Pitch, NPT - HSS STI 中打タップ
	Metric Coarse Metrisch Standard Métrique à pas normaux Métrica gruesa 公制粗牙螺紋 ミリ並目		British Standard Brass British Standard Brass Standard Angliais BSCY Rosca inglesa BSC 英国标准 (黃銅) 英国規格真鍮		MC, MF, UNC, UNF, 8 Pitch, NPT – HSS <b>Taper</b> STI Tap MC, MF, UNC, UNF, 8 Steigung, NPT – HSS <b>fertigschneider</b> STI-Gewindeschneider Taraud STI <b>ébaucheur</b> MC, MF, UNC, UNF, 8 pas, NPT – HSS Macho STI cónico, Nº 1 – MC, MF, UNC, UNF, 8 UN, NPT 高速鋼螺套專用絲錐 (頭錐) 適用於 MC, MF, UNC, UNF, 8 UN, NPT 螺紋 MC, MF, UNC, UNF, 8 Pitch, NPT - HSS STI 先打タップ
	Metric Fine Metrisch Fein Métrique à pas fins Métrica fina 公制細牙螺紋 ミリ細目		Installed Insert Length = Diameter x 1.0 Installierte Einsatzlänge = Durchmesser x 1.0 Longueur du filet rapporté installé = Diamètre x 1.0 Longitud del inserto instalado = Diámetro x 1 安装后螺套长度 = 直径 * 1.0 挿入インサート長さ = 直径 x 1.0		BSW, BSF, BSP – HSS <b>Bottoming</b> STI Tap BSW, BSF, BSP – HSS <b>vorschneider</b> STI - Gewindeschneider Taraud <b>finisseur</b> STI BSW, BSF, BSP – HSS Macho STI de acabado, Nº 3 – BSW, BSF, BSP 高速鋼螺套專用絲錐 (底錐) 適用於 BSW, BSF, BSP 螺紋 BSW, BSF, BSP - HSS STI 先打タップ
	Unified National Coarse Unified National Standard Pas normal américain Rosca Americana gruesa 統一標準粗牙螺紋 ユニファイ並目		Installed Insert Length = Diameter x 1.5 Installierte Einsatzlänge = Durchmesser x 1.5 Longueur du filet rapporté installé = Diamètre x 1.5 Longitud del inserto instalado = Diámetro x 1.5 安装后螺套长度 = 直径 * 1.5 挿入インサート長さ = 直径 x 1.5		BSW, BSF, BSP – HSS <b>Intermediate</b> STI Tap BSW, BSF, BSP – HSS <b>Einschnitt</b> STI Gewindeschneider Taraud STI <b>intermédiaire</b> BSW, BSF, BSP – HSS Macho STI intermedio, Nº 2 – BSW, BSF, BSP 高速鋼螺套專用絲錐 (中錐) 適用於 BSW, BSF, BSP 螺紋 BSW, BSF, BSP - HSS STI 中打タップ
	Unified National Fine Unified National Fein Pas fin américain Rosca Americana fina 統一標準細牙螺紋 ユニファイ細目		Installed Insert Length = Diameter x 2.0 Installierte Einsatzlänge = Durchmesser x 2.0 Longueur du filet rapporté installé = Diamètre x 2.0 Longitud del inserto instalado = Diámetro x 2 安装后螺套长度 = 直径 * 2.0 挿入インサート長さ = 直径 x 2.0		BSW, BSF, BSP – HSS <b>Taper</b> STI Tap BSW, BSF, BSP – HSS <b>fertigschneider</b> STI-Gewindeschneider Taraud STI <b>ébaucheur</b> BSW, BSF, BSP – HSS Macho STI cónico, Nº 1 – BSW, BSF, BSP 高速鋼螺套專用絲錐 (頭錐) 適用於 BSW, BSF, BSP 螺紋 BSW, BSF, BSP - HSS STI 先打タップ
	British Standard Whitworth British Standard Whitworth Pas normal britannique Rosca inglesa gruesa 英制標準惠氏螺紋 英國規格ワイトワース		Installed Insert Length = Diameter x 2.5 Installierte Einsatzlänge = Durchmesser x 2.5 Longueur du filet rapporté installé = Diamètre x 2.5 Longitud del inserto instalado = Diámetro x 2.5 安装后螺套长度 = 直径 * 2.5 挿入インサート長さ = 直径 x 2.5		BA – HSS <b>Bottoming</b> STI Tap BA – HSS <b>vorschneider</b> STI-Gewindeschneider Taraud STI <b>finisseur</b> BA – HSS Macho STI de acabado, Nº 3 – BA 高速鋼螺套專用絲錐 (底錐) 適用於 BA 螺紋 BA - HSS STI 先打タップ
	British Standard Fine British Standard Fein Pas fin britannique Rosca inglesa fina 英制標準細牙螺紋 英國規格細目		Installed Insert Length = Diameter x 3.0 Installierte Einsatzlänge = Durchmesser x 3.0 Longueur du filet rapporté installé = Diamètre x 3.0 Longitud del inserto instalado = Diámetro x 3 安装后螺套长度 = 直径 * 3.0 挿入インサート長さ = 直径 x 3.0		BA – HSS <b>Intermediate</b> STI Tap BA – HSS <b>Einschnitt</b> STI - Gewindeschneider Taraud STI <b>intermédiaire</b> BA – HSS Macho STI intermedio, Nº 2 – BA 高速鋼螺套專用絲錐 (中錐) 適用於 BA 螺紋 BA - HSS STI 中打タップ
	British Standard Pipe British Standard Pipe filet de tube britannique Rosca inglesa GAS 英制標準管螺紋 英國規格パイプ		HSS-EV <b>Spiral Flute</b> STI Tap HSS-EV <b>Gerader</b> STI - Gewindeschneider Taraud STI à rainures <b>hélicoïdales</b> HSS-EV Macho STI Hélicoïdal 螺旋槽絲錐 HSS-EV スパイラルフルート STI タップ		BA – HSS <b>Taper</b> STI Tap BA – HSS <b>fertigschneider</b> STI - Gewindeschneider Taraud STI <b>ébaucheur</b> BA – HSS Macho STI cónico, Nº 1 – BA 高速鋼螺套專用絲錐 (頭錐) 適用於 BA 螺紋 BA - HSS STI 先打タップ
	National Pipe Taper National Pipe Konus tube conique américain Rosca cónica Americana 標準管螺紋 アメリカ規格管用テーパ		HSS-EV <b>Spiral Point</b> (Gun Nose) STI Tap HSS-EV <b>Drahtspitzen</b> (Tiefloch-) STI - Gewindeschneider Taraud STI à <b>entrée hélicoïdale</b> (nez mitrailleur) HSS-EV Macho STI con entrada corregida F/B 螺旋尖絲錐 HSS-EV スパイラルポイント(ガンノーズ) STI タップ		Spark Plug – HSS <b>Pilot Nose</b> STI Tap Zündkerze – HSS STI - Gewindeschneider mit <b>Führungszapfen</b> Taraud STI à <b>embout pilote</b> bougie d'allumage - HSS Macho STI con doble entrada para bujías 火花塞專用絲錐 スパークプラグ - HSS パイロットノーズ STI タップ

PowerCoil Wire Thread Inserts strengthen tapped threads in light weight parent materials such as aluminium. They are helically wound inserts made from high quality chromium nickel stainless steel with a diamond shaped cross section.

PowerCoil inserts are used in OEM applications in a wide range of industry sectors including aerospace, automotive, military and electronics. They are inexpensive when compared to other inserts and simple to install, yet are extremely tough, wear resistant and corrosion resistant.

Most importantly, PowerCoil inserts allow the stress loading from the bolt or similar threaded part to be more evenly distributed over the threads in the parent material.

In addition to PowerCoil standard 'free running' inserts, 'screw locking' inserts are also available. These inserts have polygonal grip coils within the length of the insert which exert radial pressure on the male thread, thereby gripping the bolt and preventing it from loosening under vibration or impact.

In addition to stainless steel, PowerCoil inserts can be made from Phosphor Bronze, Inconel or Nimonic 90 depending on the application. They can also be supplied with different surface finishes and coatings including cadmium, silver and zinc plating and dry film lubricant.

A complete range of Screw Thread Insert (STI) taps are available as well as low, medium and high volume installation tools and a wide range of individual and workshop. For further information we recommend you consult the technical pages in this guide, the PowerCoil website: [www.powercoil.com.au](http://www.powercoil.com.au) or call your customer service representative.





**Part No. 3520 - 12,00 X 1,5D**

35 PowerCoil - Stainless Steel

**DIAMETER**  
XX, XX Metric  
XX / XX Imperial

- |    |                 |    |      |
|----|-----------------|----|------|
| 20 | Metric Coarse   | 32 | UNC  |
| 21 | Metric Fine     | 34 | UNF  |
| 22 | Spark Plug      | 44 | BA   |
| 23 | Metric Fine     | 46 | BSP  |
| 24 | Metric Fine     | 52 | NPT  |
| 28 | BSW             | 60 | BSC  |
| 30 | BSF             | 70 | 8-UN |
| 00 | Multifunctional |    |      |

- X,X D Insert length as a factor of nominal screw
- IR PowerCoil strip-feed reel  
SL PowerCoil screw locking  
K PowerCoil thread repair kit  
P PowerCoil Hang sell insert packet  
WK PowerCoil workshop kit
- HIT Hand installation tool  
HIP Prewinder installation tool  
MIT Machine installation tool  
HIM Hex drive installation mandrel  
MIP Pneumatic installation tool  
TB Tang break tool  
STB Spring loaded tang break tool  
PTB Pneumatic tang break tool  
RT Removal/extraction tool
- LH Left Hand
- GC Gauge STI 4H5H tolerance  
GM Gauge STI 6H tolerance

- PB Phosphor bronze  
IC Iconel X-750  
NM Nimonic 90  
NT Nitronic 60  
Y 316 Stainless Steel  
CD Cadmium plate  
ZN Zinc plate  
AG Silver plate  
W Dry film lubricant  
PF Xylan® 5251/840 Black
- I Tap Intermediate STI  
T Tap Taper STI  
B Tap Bottoming STI  
SF Tap Spiral Flute STI  
SP Tap Spiral Point STI  
FT Tap Fluteless STI



**Teil-Nr. 3520 - 12,00 X 1,5D**

35 PowerCoil - Edelstahl

**DURCHMESSER**  
XX, XX Metrisch  
XX / XX Zoll

- |    |                   |    |      |
|----|-------------------|----|------|
| 20 | Metrisch Standard | 32 | UNC  |
| 21 | Metrisch fein     | 34 | UNF  |
| 22 | Zündkerze         | 44 | BA   |
| 23 | Metrisch fein     | 46 | BSP  |
| 24 | Metrisch fein     | 52 | NPT  |
| 28 | BSW               | 60 | BSC  |
| 30 | BSF               | 70 | 8-UN |
| 00 | Multi-funktionell |    |      |

- X,X D Einsatzlänge als Faktor der Nennschraube
- IR PowerCoil Stripfeed-Rolle  
SL PowerCoil Screwlockung  
K PowerCoil Gewindereparatur-Sortiment  
P PowerCoil Hangsell-Einsatzpaket  
WK PowerCoil Werkstatt-Sortiment
- HIT Handeinbauwerkzeug  
HIP Vorspannpatronen-Einbauwerkzeug  
MIT Maschinelles Einbauwerkzeug  
HIM Hex-Drive-Einbauspindel  
MIP Pneumatisches Einbauwerkzeug  
TB Zapfenbrecher  
STB Vorgespannter Zapfenbrecher  
PTB Pneumatischer Zapfenbrecher  
RT Ausdrehwerkzeug
- LH Linksdrehend
- GC Maß STI - 4H5H Toleranz  
GM Maß STI - 6H Toleranz

- PB Phosphor bronze  
IC Iconel X-750  
NM Nimonic 90  
NT Nitronic 60  
Y 316 Edelstahl  
CD Kadmiert  
ZN Galvanisiert  
AG Versilbert  
W Trockenschmiermittel  
PF Xylan® 5251/840 Schwarz
- I Gewindebohrer Einschnitt STI  
T Gewindebohrer - konisch STI  
B Gewindebohrer bodengehend STI  
SF Gewindebohrer Gerade STI  
SP Gewindebohrer Drallspitze STI  
FT Gewindebohrer ohne Nuten STI



**Pièce Nr. 3520 - 12,00 X 1,5D**

35 PowerCoil - Acier inoxydable

**DIAMETER**  
XX, XX Métrique  
XX / XX Impérial

- |    |                        |    |      |
|----|------------------------|----|------|
| 20 | Métrique à pas normaux | 32 | UNC  |
| 21 | Métrique à pas fins    | 34 | UNF  |
| 22 | Bougie d'allumage      | 44 | BA   |
| 23 | Métrique à pas fins    | 46 | BSP  |
| 24 | Métrique à pas fins    | 52 | NPT  |
| 28 | BSW                    | 60 | BSC  |
| 30 | BSF                    | 70 | 8-UN |
| 00 | Multifonctionnel       |    |      |

- X,X D Longueur du filet rapporté tel que facteur de serrage nominal
- IR Moulinet d'entraînement de bande PowerCoil  
SL PowerCoil à frein de vis  
K kit de réparation de filets PowerCoil  
P Paquet de filets rapportés PowerCoil dans un emballage à système d'accroche  
WK PowerCoil kit d'atelier
- HIT Outil d'installation manuel  
HIP outil d'installation de pré-enroulage  
MIT Outil d'installation de la machine mandrin d'installation Hex  
HIM Outil pneumatique d'installation  
MIP Tenon  
TB Tenon  
STB Tenon à ressort  
PTB Pneumatic tang break tool  
RT Outil de dépose / d'extraction
- LH Coupe à gauche
- GC Jauge STI de tolérance 4H5H  
GM Jauge STI de tolérance 6H

- PB Bronze de phosphore  
IC Iconel X-750  
NM Nimonic 90  
NT Nitronic 60  
Y Acier inoxydable 316  
CD Plaque de cadmium  
ZN Plaque de zinc  
AG Plaque d'argent  
W film de lubrifiant hydrofuge  
PF Xylan® 5251/840 noir
- I Taraud STI intermédiaire  
T Taraud STI ébaucheur  
B Taraud STI finisseur  
SF Taraud STI à rainures hélicoïdales  
SP Taraud STI à entrée hélicoïdale  
FT Taraud STI sans goujure



## No. De Parte 3520-12,00X1,5D

35 PowerCoil en acero inoxidable		DIAMETER XX, XX Métrico XX / XX Pulgadas	
20 Métrico grueso	32 UNC		
21 Métrico fino	34 UNF		
22 Bujía	44 BA		
23 Métrico fino	46 BSP		
24 Métrico fino	52 NPT		
28 BSW	60 BSC		
30 BSF	70 8-UN		
00 Multifuncional			

X, X D	Longitud del inserto teniendo en cuenta la longitud del tornillo	PB	Bronce con fósforo
IR	Power Coil, Carrete de alimentación de insertos	IC	Iconel X-750
SL	Power Coil, insertos autoblocantes (de seguridad) (autofrenantes)	NM	Nimonic 90
K	Power Coil, Juego de reparación de roscas	NT	Nitronic 60
P	Power Coil, paquetes de insertos para colgar	Y	Acero Inoxidable 316
WK	Power Coil, Juegos para taller	CD	Terminado en cadmio
HIT	Herramienta de instalación manual	ZN	Terminado de zinc
HIP	Herramienta de instalación de roscas	AG	Terminado de plata lubricado en seco
MIT	Herramienta para insertar a máquina	W	Xylan® 5251/840 negro
HIM	Herramienta para insertar con mango hexagonal	I	Macho 2º o intermedio STI
MIP	Herramienta de instalación neumática	T	Macho 1º o cónico STI
TB	Herramienta rompe arrastre	B	Macho 3º o de acabado STI
STB	Herramienta rompe arrastre automático	SF	Macho helicoidal STI
PTB	Herramienta rompe arrastre neumática	SP	Macho con entrada corregida STI
RT	Herramienta extractora de insertos	FT	Macho laminación STI
LH	Giro izquierda		
GC	Roscas en tolerancia STI 4H5H		
GM	Roscas en tolerancia STI 6H		



## Part No. 3520 - 12,00 X 1,5D

35 PowerCoil - 不锈钢		直径 XX, XX 公制 XX / XX 英制	
20 公制粗牙	32 统一标准粗牙螺纹		
21 公制细牙	34 统一标准细牙螺纹		
22 火花塞	44 英国 BA 标准螺纹		
23 公制细牙	46 英制标准管螺纹		
24 公制细牙	52 标准管螺纹		
28 英制标准惠氏螺纹	60 英国 BSC 螺纹		
30 英制标准细牙螺纹	70 英制 8 螺纹		
00 多功能的			

X, X D	螺孔倍率因子	PB	磷铜
IR	PowerCoil 盘装螺套	IC	因科镍合金
SL	PowerCoil 自锁型螺套	NM	铌钼合金
K	PowerCoil 螺纹修理套装	NT	Nitronic60 合金
P	PowerCoil 悬挂螺套包	Y	316 不锈钢
WK	PowerCoil 车间修理套装	CD	镀镉
HIT	手动安装工具	ZN	镀锌
HIP	预拉伸安装工具	AG	镀银
MIT	机用安装工具	W	干性润滑剂涂层
HIM	HEX 安装心轴	PF	Xylan® 5251/840 黑色
MIP	气动安装工具	I	中锥
TB	安装柄折断工具	T	头锥
STB	伸缩折断工具	B	底锥
PTB	气动折断工具	SF	螺旋槽丝锥
RT	螺套拆除工具	SP	螺旋丝锥
LH	左手	FT	挤压丝锥
GC	STI 专用量规 (4H, 5H)		
GM	STI 专用量规 (6H)		



## 部品番号 3520-12,00X1,5D

35 PowerCoil - ステンレス網		径 XX, XX メートル法 XX / XX インチ法	
20 ミリ並目	32 UNC		
21 ミリ細目	34 UNF		
22 スパークプラグ	44 BA		
23 ミリ細目	46 BSP		
24 ミリ細目	52 NPT		
28 BSW	60 BSC		
30 BSF	70 8-UN		
00 多機能性			

X, X D	呼びねじ寸法の倍数としてのインサートの長さ	PB	りん青銅
IR	Power Coil ストリップフィードリール	IC	インコネルX-750
SL	Power Coil ロックタイプ	NM	ナイモニック90
K	Power Coil ねじ山補修キット	NT	ニトロニック60
P	Power Coil ハングセルインサートパッケージ	Y	316ステンレス網
WK	Power Coil 作業キット	CD	カドミウムメッキ
HIT	手動挿入工具	ZN	亜鉛メッキ
HIP	ブリウインダー挿入工具	AG	銀メッキ
MIT	電動挿入工具	W	ドライフィルム潤滑材
HIM	6角ドライブ挿入マンドレル	PF	Xylan® 5251/840 ブラック
MIP	エアース挿入工具	I	STI 中タップ
TB	タンク折取工具	T	STI 先タップ
STB	スプリング式タンク折取工具	B	STI 上げタップ
PTB	エアースタンク折取工具	SF	STI スパイラルフルートタップ
RT	取出し/抜取り工具	SP	STI スパイラルポイントタップ
LH	左(巻き方向)	FT	STI フルードレス溝なしタップ
GC	STI 4H5H 公差ゲージ		
GM	STI 6H 公差ゲージ		



**powercoil**<sup>®</sup>  
wire thread insert system

Introduction to Wire Thread Inserts.....	2
Repair Kits.....	6
Workshop (Range) Kits.....	11
Insert Hang Sell (Retail) Packets.....	13
Merchandisers .....	23
Bulk Inserts .....	26
Strip Feed .....	43
STI Taps .....	46
Installation and Removal Tools.....	51
<b>Technical</b> – PowerCoil .....	72
<b>German, French, Spanish, Chinese, Japanese</b>	
Introduction to PowerCoil® Wire Thread Inserts.....	57

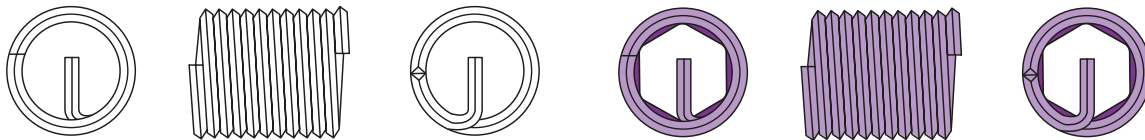

Manufactured from high quality chromium nickel stainless steel, PowerCoil Wire Thread Inserts provide high strength internal threads that resist the effects of temperature and corrosion. Their unique design ensures superior threads whose compound performance cannot be reproduced by any other single fastening method. Available in two basic forms, free running or screw locking, they are much lighter and less expensive than any other equivalent type of thread insert and because of their compact size they can generally be incorporated into existing designs where no previous provision has been made.

**FREE RUNNING**

Produced from precision profiled austenitic stainless steel wire wound into a helical spiral, PowerCoil free running inserts have a spring like appearance. When installed, using any one of a variety of manual or automatic tools, they provide strong permanent internal threads which resist heat and corrosion. Once fitted, their position is maintained by the action of radial pressure between their coils and the flanks of the tapped hole. This pressure exists because their free diameter is larger by a calculated amount, than their installed diameter.

**SCREW LOCKING**

Screw locking (or prevailing torque) inserts are of particular value in applications subject to the effects of cyclic vibration or impact. In addition to the benefits afforded by free running inserts, PowerCoil screw locking inserts offer the additional security of prevailing locking torque. This is achieved by the action of one or more polygonal grip coils positioned within the insert's length, which exert radial pressure on the male thread. Each grip coil consists of a number of tangential locking chords which protrude inside the minor diameter of the normal free running coils. As the male thread passes through these grip coils, the locking flats are displaced thus exerting radial pressure or prevailing torque on the male thread. On removal of the male thread, the locking coils relax to their original form permitting repeated assembly whilst retaining a measurable level of prevailing torque.

Note: It is recommended that only close fit plated or lubricated bolts or screws are used with screw locking inserts.

**FEATURES & BENEFITS**

For many years, helically coiled wire thread inserts have been vastly underestimated. The popular misconception that they were designed for the repair of damaged threads has given this unique fastener a false image.

They are much lighter and less expensive than any other equivalent type of thread insert and because of their compact size, can generally be introduced into existing designs where no previous provision has been made. Unlike many other economic measures, their introduction increases quality and performance whilst reducing overall product cost. Their introduction may result in the use of thinner sections or lighter parent materials without sacrificing thread strength.

They protect tapped threads against failures due to stripping, seizing, corrosion and wear. PowerCoil wire thread inserts are produced from austenitic stainless steel wire which is work hardened to a tensile strength above 200,000psi and a hardness of Rc43-50. The inserts have an exceedingly smooth surface finish which virtually eliminates friction-induced thread erosion.

The continuous helically coiled design negates the need for thick wall structures to support the internal and external threads - the diamond profile wire coil is the thread. PowerCoil wire thread inserts can be installed in reduced size bosses or flanges

and within constricted areas – saving space and weight while providing high strength.

A boss radius equal to the nominal bolt diameter is usually sufficient.

A complete range of installation tools are available to suit specific production techniques. A range of hand tools exist for small runs and repairs; electric and pneumatic tools are available for high volume production requirements.

**STRENGTH**

Due to their flexibility, wire thread inserts create internal threads which have a much improved distribution of residual stress loading when compared with conventional tapped holes, where 75% of the shearing forces are carried by the first three threads in the tapped hole. The flexibility of wire thread inserts helps to compensate for pitch and flank angle errors, inherent in normal tapped holes, and significantly enhances the load bearing capacity by deflecting the residual forces into a helical hoop stress which is dispersed into the wall of the tapped hole. This enables the design to be confidently based on the bolt strength utilising smaller and shorter threads even when used in low strength materials.

The high tensile coils of a wire thread insert undergo a diameter reduction during installation. The outward spring-like force of the coils "locks" the insert into place.

Each coil can flex independently to contact the greatest amount of parent material thread surface. Both static and dynamic load bearing capabilities are improved.

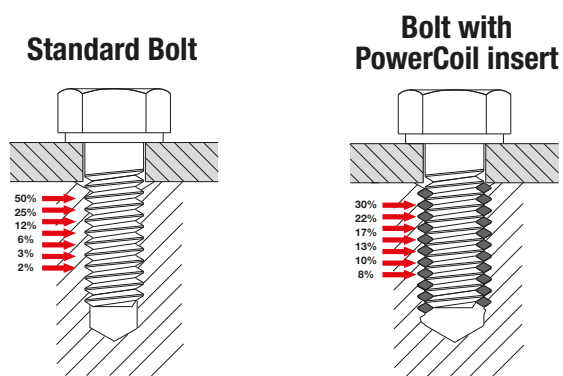

**ELIMINATE STRESS**

Virtually no stress is introduced into the parent material because there is no staking, locking, swaging or keying in place. The outward "spring action" of the insert holds it in place.

**WEAR RESISTANCE**

The combination of material hardness and the brilliant surface finish of wire thread inserts creates internal threads in which wear due to thread friction is virtually eliminated. This is of particular value in applications requiring repeated assembly & disassembly. The low frictional coefficient ensures that virtually all of the applied assembly torque is converted into clamping load. Thus providing threads that stay tight.

**CORROSION PROTECTION**

The 18/8 austenitic stainless steel wire used in PowerCoil inserts resists corrosion under normal environmental conditions. Galvanic action within the thread assembly is reduced, increasing the life of the fastening assembly.

Galvanic corrosion is most significant form of corrosion affecting

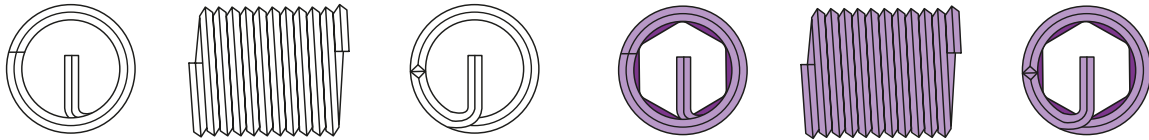

inserts and fasteners. Galvanic corrosion occurs when dissimilar metals are in contact in the presence of an electrolytic solution. All metals exhibit different degrees of “activity” or “nobility” and can be arranged in a galvanic series of increasing activity. Gold and platinum are most noble while zinc and magnesium are most active. The most common electrolytic solution encountered is ordinary water. Seawater or salt spray is more damaging because of high concentrations of dissolved salts.

The best way to preclude galvanic corrosion is to use similar potential metals and eliminate the electrolyte conductor. The active stainless steel of PowerCoil wire thread inserts are not passivated. This minimizes the possibility of galvanic corrosion occurring when they are installed in aluminum or magnesium parent materials.

Some additional precautions for reducing galvanic corrosion are:

1. Isolate the fasteners from the electrolyte. This can be done through gasketing or sealing.
2. Specify cadmium plated inserts. The cadmium plate provides a sacrificial barrier against corrosion. In addition, the cadmium plate has lubricating properties that minimize galling when stainless steel screws are used.
3. Apply corrosion inhibiting pastes or compounds to the screw. These include zinc chromate primer (MIL-P-8585) and strontium chromate primer (MIL-P-23377). Note: Pastes applied to the PowerCoil Thread Insert can become trapped between the wire and the hole and cause loss of proper tolerance. It is therefore recommended to apply the paste only to the screw, not the insert. If zinc chromate primer is applied to the tapped hole it should be thinned and applied sparingly. The insert should be installed while the primer is still wet.
4. Specify a dry film lubricant such as molybdenum disulphide on the inserts. This provides a secondary barrier against corrosion.
5. Where practical or where it will not interfere with the completed assembly, the external joint should be coated with a suitable paint.

## MATERIALS

PowerCoil standard inserts are manufactured from fully certified, aircraft quality, 304 (18/8) austenitic stainless steel in accordance with DTD 734A. Alternative materials include 316 stainless steel and a variety of application specific surface coatings.

## ALTERNATIVE MATERIALS

### Phosphor Bronze

Non ferrous copper/tin alloy in accordance with BS2783 PB 102 EH – is suitable for operation in temperatures ranging from -200°C to +300°C.

### Inconel X-750

Heat resisting precipitation hardenable nickel base alloy (equivalent specifications SAE AS 7246, DIN/NF 3018, W.NR 2.4669, UNS N07750). Inconel X-750 is suitable for operation in temperatures ranging from -200°C to +550° degrees celsius.

### Nimonic 90

Heat resisting precipitation hardenable nickel base alloy in accordance with BS2 HR 501 (equivalent specifications W.NR 2.4632, UNS N07090).

Nimonic 90 is suitable for operation in temperatures ranging from -100°C to +650° degrees celsius.

Insert Material	Max. Temp.		Typical Applications	Coatings
	Peak	Cont.		
Stainless 304	425°C 800°F	315°C 600°F	Most general applications in all materials	FL, AG, CD
Stainless 316	425°C 800°F	315°C 600°F	Increased corrosion resistance for salt water applications	FL, AG, CD
Phosphor Bronze	300°C 572°F	235°C 455°F	Copper parts, non-magnetic, low permeability applications	AG, CD
Inconel X-750	650°C 1200°F	550°C 1020°F	Aerospace, turbines, corrosive environments, high temp. use	AG
Nimonic 90	650°C 1200°F	550°C 1020°F	Aerospace and turbine applications	AG

## ALTERNATIVE FINISHES & COATINGS

### Cadmium Plate

Electro-deposited Cadmium in accordance with DTD 904/Def Stan 03-19 (equivalent specifications FED. QQ-P-416, LN 9368). Cadmium plating provides an excellent barrier between dissimilar metals dramatically reducing the effects of galvanic corrosion, its high lubricity and excellent corrosion resistance prevents seizure and galling between threaded components. Cadmium plate is suitable for operation in temperatures ranging from -200°C to +235°C.

### Cadmium plated parts must not be

- subjected to temperatures exceeding 235°C (455°F)
- come into contact with fuel or hot oil
- come into contact with food or drinking water
- be used with titanium components (either directly or indirectly). At elevated temperatures embrittlement and subsequent component failure may occur.
- Cadmium is highly toxic – consequently extreme care must be taken when shipping, handling and installing.

### Zinc Plate

Electrolytically deposited zinc in accordance with BS 3382. Electro-deposited zinc is the most widely applied electroplated finish in industry. Zinc is suitable for operation in temperatures ranging from -200°C to +250°C.

### Silver Plate

Electrolytically deposited silver in accordance with DTD 939. Silver plating is used to prevent seizure and galling between thread components in high temperature applications and is most commonly applied to aero-engine fasteners. Silver plate is suitable for operation in temperatures ranging from -200°C to +650°C. Silver plated wire inserts may be installed in various materials including aluminium alloys, magnesium alloys, corrosion and heat resistant materials etc.

**Silver plated inserts are not recommended** for installation in titanium alloy which may exceed a service temperature of 300°C ( 570°F). Stress corrosion as a result of the combination of silver and titanium may occur in the housing material.

### Dry Film Lubricant

Solid film heat cured molybdenum disulphide dry film lubricant coating in accordance with MIL-L-0046010 provides a low frictional coefficient coating with excellent load bearing capabilities. Dry film lubricant prevents seizing and galling between threaded components and is particularly effective in screw locking insert applications. Dry film lubricant is suitable for operation in temperatures ranging from -100°C to +250°C.

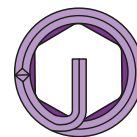
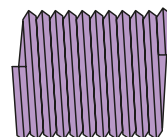
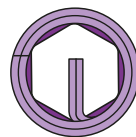
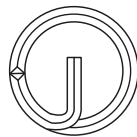
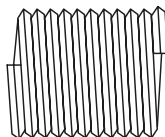
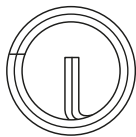

Plating / Finish	Part No. Suffix	Applicable Process Specification
Silver Plating	AG	DTD 939
Cadmium Plating	CD	QQP-416 or DEF STD 03-19
Dry Film Lubricant	FL	MIL-L-8937 or MIL-L-46010
Red Dye	–	Applied to locking inserts for identification purposes*

\* other color dyes may also be utilised for specific identification purposes

**SELECTION OF CORRECT INSERT LENGTH**

PowerCoil wire thread inserts are available in all popular thread types. Five insert lengths are available for each thread size. It is important to select the correct insert length in order to balance the bolt tensile strength against the shear strength of the parent material. The five insert lengths (recommended thread engagement of the PowerCoil wire thread insert), 1D, 1.5D, 2D, 2.5D and 3D are shown in the shaded area of the table below. These are calculated numbers since the inserts cannot be measured in the free (un-installed) state. The numbers are multiples of the nominal thread size, or diameter, of the insert. The actual insert lengths in the installed position are listed in the insert selection tables. There they represent the actual installed length plus 1/2 pitch. Using the table below, an insert length can be selected which will produce a thread system strong enough to fracture a bolt before it will strip or damage either the parent material or the insert.

**Recommended Nominal Insert lengths Based on Parent Material Versus Bolt Material Strengths**

**UNIFIED** (source BS7752 Part 1:1994)

Shear Strength of Parent Material (KSI)	Bolt Material Minimum Ultimate Tensile Strength (KSI)								
	54	75	96	108	125	132	160	180	220
10	2.0	2.5	3.0	3.0	–	–	–	–	–
15	1.5	1.5	2.0	2.5	2.5	3.0	–	–	–
20	1.0	1.5	1.5	2.0	2.0	2.0	2.5	3.0	3.0
25	1.0	1.0	1.5	1.5	1.5	2.0	2.0	2.5	2.5
30	1.0	1.0	1.0	1.5	1.5	1.5	2.0	2.0	2.5
40	1.0	1.0	1.0	1.0	1.0	1.5	1.5	1.5	2.0
50	1.0	1.0	1.0	1.0	1.0	1.0	1.0	1.5	1.5

EXAMPLE: If parent material shear strength is 10KSI and the bolt tensile strength is 54 KSI, the correct insert length is 2.0 diameters (2D).

**METRIC**

Shear Strength of Parent Material (MPa)	Bolt Material Minimum Ultimate Tensile Strength (MPa)							
	300	400	500	600	800	1000	1200	1400
70	1.5	2.0	2.5	2.5	–	–	–	–
100	1.0	1.5	1.5	2.0	2.5	3.0	–	–
150	1.0	1.0	1.5	1.5	2.0	2.0	2.5	3.0
200	1.0	1.0	1.0	1.0	1.5	1.5	2.0	2.5
250	1.0	1.0	1.0	1.0	1.0	1.5	1.5	2.0
300	1.0	1.0	1.0	1.0	1.0	1.5	1.5	1.5
350	1.0	1.0	1.0	1.0	1.0	1.0	1.5	1.5

EXAMPLE: If parent material shear strength is 150Mpa and the bolt tensile strength is 600Mpa, the correct insert length is 1.5 diameters (1.5D).

**BOLT PROJECTION**

PowerCoil wire thread inserts are designed to be used with standard, readily available bolts and screws that require no special hardware.

The bolt must engage the entire insert length to achieve maximum assembly strength. To ensure against partial engagement, it is recommended that the tang always be removed. This will also guarantee that the locking coil(s) will be engaged by the full threads of the bolt. If design parameters prevent this, contact PowerCoil for assistance.

**NOTES:**

1. Bolt tensile strengths are specified minimums. When choosing an insert length, consideration should be given the maximum tensile strength allowed by the bolt drawing or procurement specification.
2. Service temperatures can cause significant variations in strength values, therefore compensation should be allowed.
3. The importance of shear values should be kept in mind because the parent material is subject to shear ing stress near the major diameter of the tapped threads.
4. When the strength values fall between two values in the tables, use next lower material shear value, or the next higher bolt tensile strength value.
5. To achieve maximum strength, bolt length and thread length as well as full tapped thread depth must be sufficient to assure full thread engagement over the entire length of the insert.

**SCREW LOCKING (PREVAILING TORQUE) INSERTS**

Screw Locking PowerCoil wire thread inserts are designed for applications subject to the effects of cyclic vibration or impact. The screw locking insert exerts a prevailing torque on male threaded fasteners to prevent loosening due to vibration or impact. They eliminate the need for other, less desirable and costly locking mechanisms. They are excellent in “adjusting screw” applications by preventing the male fastener from creeping.

**HOW SCREW LOCKING INSERTS WORK**

PowerCoil Screw Locking inserts offer the additional security of prevailing locking torque. This is achieved by the action of one or more polygonal grip coils positioned within the insert's length, which exert radial pressure on the male thread. Each grip coil consists of a number of tangential locking chords which protrude inside the minor diameter of the normal free running coils. As the male thread passes through these grip coils, the locking flats are displaced and exert radial pressure (prevailing torque) on the male thread.

On removal of the male thread, the locking coils relax to their original form permitting repeated assembly whilst retaining a measurable level of prevailing torque.

**Please note:**

It is recommended that only close fit plated or lubricated bolts or screws are used with screw locking PowerCoil wire thread inserts. When using heat treated unplated or stainless steel bolts, an anti-seize compound, e.g., molybdenum disulfide, must be used in order to minimize galling and assure maximum cycle life. Wear life of screw or bolt using PowerCoil screw locking wire thread inserts can also be improved by specifying dry film lubrication or cadmium plating.



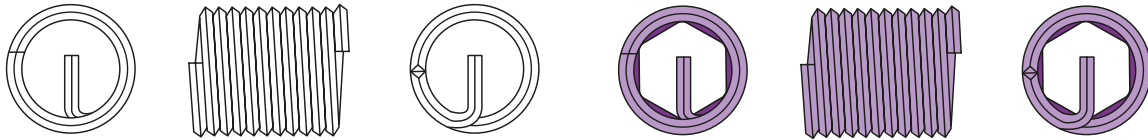

### LOCATION OF LOCKING COILS

For 1D, 1.5D, and 2D diameter lengths: The center of the locking coil (or coils) equals 1/2 the number of free coils. For 2.5D and 3D diameter lengths: The locking coil is located the same distance from the tang as 2D length inserts.

Screw locking inserts are dyed red for easy identification purposes only. It is alcohol soluble and can be removed if desired.

### RED DYE COATING

PowerCoil screw locking inserts are generally colour coded with an organic red dye for identification purposes. The dye does not affect the installation or performance of the insert and does not need to be removed (in most situations). In situations requiring extreme cleanliness (such as assembly of precision instruments in clean room conditions) the dye may be removed by soaking the inserts in a denatured alcohol solution prior to installation.

### POWERCOIL LOCKING INSERT TORQUE VALUES

#### METRIC COARSE

Thread mm x mm	Torque Max (Nm)	Torque Min (Nm)
M2.2x0.45	0.14	0.02
M2.5x0.45	0.23	0.05
M3.0x0.50	0.45	0.10
M3.5x0.60	0.68	0.12
M4.0x0.70	0.90	0.15
M5.0x0.80	1.60	0.30
M6.0x1.00	3.00	0.40
M7.0x1.00	4.50	0.60
M8.0x1.25	6.00	0.80
M10.0x1.50	10.50	1.40
M12.0x1.75	15.50	2.10
M14.0x2.00	23.50	3.00
M16.0x2.00	31.50	4.20
M18.0x2.50	42.00	5.50
M20.0x2.50	54.00	7.00
M22.0x2.50	67.50	9.00
M24.0x3.00	80.00	10.50
M27.0x3.00	94.00	12.00
M30.0x3.50	108.00	14.00
M33.0x3.50	122.00	15.50
M36.0x4.00	136.00	17.50
M39.0x4.00	150.00	19.50

#### METRIC FINE

Thread mm x mm	Torque Max (Nm)	Torque Min (Nm)
M8.0x1.00	6.00	0.80
M10.0x1.00	10.50	1.40
M10.0x1.25	10.50	1.40
M12.0x1.25	15.50	2.10
M12.0x1.50	15.50	2.10
M14.0x1.50	23.50	3.00
M16.0x1.50	31.50	4.20
M18.0x1.50	42.00	5.50
M20.0x1.50	54.00	7.00
M22.0x1.50	67.50	9.00
M18.0x2.00	42.00	5.50
M20.0x2.00	54.00	7.00
M22.0x2.00	67.50	9.00
M24.0x2.00	80.00	10.50
M27.0x2.00	94.00	12.00
M30.0x2.00	108.00	14.00
M33.0x2.00	122.00	15.50
M36.0x2.00	136.00	17.50
M39.0x2.00	150.00	19.50
M36.0x3.00	136.00	17.50

Locking torque values conform to  
MP3329, MP3330, MP3331

#### UNIFIED NATIONAL COARSE – UNC

Thread inch x tpi	Torque Max (lb in)	Torque Min (lb in)
2x56	1.25	0.19
3x48	2.00	0.44
4x40	3.00	0.63
5x40	4.69	0.81
6x32	6.00	1.00
8x32	9.00	1.50
10x24	13.00	2.00
12x24	24.00	3.00
1/4x20	30.00	4.50
5/16x18	60.00	7.50
3/8x18	80.00	12.00
7/16x14	100.00	16.50
1/2x13	150.00	24.00
9/16x12	200.00	30.00
5/8x11	300.00	40.00
3/4x10	400.00	60.00
7/8x9	600.00	82.00
1x8	800.00	110.00
11/8x7	900.00	137.00
11/4x7	1000.00	165.00
13/8x6	1150.00	185.00
11/2x6	1350.00	210.00

#### UNIFIED NATIONAL FINE – UNF

Thread inch x tpi	Torque Max (lb in)	Torque Min (lb in)
3x56	0.13	0.44
4x48	0.19	0.63
6x40	6.00	1.00
8x36	9.00	1.50
10x32	13.00	2.00
1/4x28	30.00	3.50
5/16x24	60.00	6.50
3/8x24	80.00	9.50
7/16x20	100.00	14.00
1/2x20	150.00	18.00
9/16x18	200.00	24.00
5/8x18	300.00	32.00
3/4x16	400.00	50.00
7/8x14	600.00	70.00
1x12	800.00	90.00
11/8x12	900.00	117.00
11/4x12	1000.00	143.00
13/8x12	1150.00	165.00
11/2x12	1350.00	190.00

Locking torque values conform to  
NASM8846

**Note:** It is also essential that the bolt fully engages all insert coils for maximum strength.

PowerCoil screw locking inserts can be designed to suit a customer's specific needs. In certain instances and applications prevailing torque can be lessened or increased to cater for a specific application. In these situations please contact your PowerCoil representative to discuss your specific requirements.

**Please Note:** Installation of PowerCoil screw locking inserts requires the use of a pre-winder tool. Please discuss other installation options with your PowerCoil agent.



<b>GROUP</b>	<b>PCRK</b>
INSERT TYPE	WIRE THREAD
INSERT MATERIAL	304 STAINLESS STEEL
STYLE	<b>FREE RUNNING</b>

**METRIC COARSE**

INSERT				INCLUDED IN KIT				
MM	MM	INSTALLED LENGTH	PART #	#	MM	PART #	PART #	PART #
M2	0,40	1,5D 3,00MM	3520-2.00K	20	2,1	3520-2.00I	3500-HIT2	3500-TB1
M2.2	0,45	1,5D 3,30MM	3520-2.20K	20	2,3	3520-2.20I	3500-HIT2	3500-TB2
M2.5	0,45	1,5D 3,75MM	3520-2.50K	20	2,6	3520-2.50I	3500-HIT3	3500-TB3
M3	0,50	1,5D 4,50MM	3520-3.00K	20	3,2	3520-3.00I	3500-HIT4	3500-TB4
M3.5	0,60	1,5D 5,25MM	3520-3.50K	20	3,7	3520-3.50I	3500-HIT5	3500-TB5
M4	0,70	1,5D 6,00MM	3520-4.00K	20	4,2	3520-4.00I	3500-HIT6	3500-TB6
M5	0,80	1,5D 7,50MM	3520-5.00K	20	5,2	3520-5.00I	3500-HIT8	3500-TB8
M6	1,00	1,5D 9,00MM	3520-6.00K	20	6,3	3520-6.00I	3500-HIT9	3500-TB9
M7	1,00	1,5D 10,50MM	3520-7.00K	20	7,3	3520-7.00I	3500-HIT10	3500-TB11
M8	1,25	1,5D 12,00MM	3520-8.00K	20	8,3	3520-8.00I	3500-HIT11	3500-TB12
M9	1,25	1,5D 13,50MM	3520-9.00K	15	9,4	3520-9.00I	3500-HIT13	3500-TB12
M10	1,50	1,5D 15,00MM	3520-10.00K	15	10,4	3520-10.00I	3500-HIT13	3500-TB13
M11	1,50	1,5D 16,50MM	3520-11.00K	10	11,4	3520-11.00I	3500-HIT14	3500-TB14
M12	1,75	1,5D 18,00MM	3520-12.00K	10	12,4	3520-12.00I	3500-HIT15	3500-TB15
M13	1,75	1,5D 19,50MM	3520-13.00K	10	13,5*	3520-13.00I	3500-HIT15	
M14	2,00	1,5D 21,00MM	3520-14.00K	10	14,5*	3520-14.00I	3500-HIT16	
M15	2,00	1,5D 22,50MM	3520-15.00K	10	15,5*	3520-15.00I	3500-HIT16	
M16	2,00	1,5D 24,00MM	3520-16.00K	10	16,5*	3520-16.00I	3500-HIT18	
M18	2,50	1,5D 27,00MM	3520-18.00K	5	18,5*	3520-18.00I	3500-HIT20	
M20	2,50	1,5D 30,00MM	3520-20.00K	5	20,8*	3520-20.00I	3500-HIT21	
M22	2,50	1,5D 33,00MM	3520-22.00K	5	22,8*	3520-22.00I	3500-HIT22	
M24	3,00	1,5D 36,00MM	3520-24.00K	5	25,0*	3520-24.00I	3500-HIT23	
M27	3,00	1,5D 40,50MM	3520-27.00K	5	28,0*	3520-27.00I	3500-HIT24	
M30	3,50	1,5D 45,00MM	3520-30.00K	5	31,0*	3520-30.00I	3500-HIT25	
M33	3,50	1,5D 49,50MM	3520-33.00K	5	34,0*	3520-33.00I	3500-HIT26	
M36	4,00	1,5D 54,00MM	3520-36.00K	5	37,0*	3520-36.00I	3500-HIT28	

\* Tapping drill not included in thread repair kit.



Some large repair kits over 24mm may be supplied with HIM tools (hex installation mandrels) in place of HIT tools (hand installation tools).

**METRIC COARSE**

INSERT				INCLUDED IN KIT				
MM	MM	INSTALLED LENGTH	PART #	#	MM	PART #	PART #	PART #
M10	1,00	1/2"	3522-10.00K	5		3522-10.00PN	3500-HIT13	3500-TB13
		0.339"		5				
M12	1,25	1/2"	3522-12.00K	5		3522-10.00PN	3500-HIT15	3500-TB15
		3/4"		5				
M14	1,25	3/8"	3522-14.00K	5		3522-14.00PN	3500-HIT17	
		1/2"		5				
		3/4"		5				
M14	1,25	8,4MM	3522-14.00K1	5		3522-14.00PN	3500-HIT17	
		12,4MM		5				
		16,4MM		5				
M18	1,50	1/2"	3522-18.00K	5		3522-18.00PN	3500-HIT20	

STI Pilot Nose Taps are used to repair damaged threads and do not require the drilling of a pilot hole.

These taps use the existing thread as a guide in tapping a straight hole. STI Pilot Nose Taps are most commonly used to tap holes for the repair of spark plug threads.



**IMPORTANT**  
It is recommended that when repairing the thread on spark plug ports that you remove the head. If you do not remove the head it is essential that you protect the engine from the ingress of chips and swarf generated by the tapping process.





<b>GROUP</b>	<b>PCRK</b>
INSERT TYPE	WIRE THREAD
INSERT MATERIAL	304 STAINLESS STEEL
STYLE	<b>FREE RUNNING</b>

METRIC FINE				INCLUDED IN KIT					
INSERT		INSTALL LENGTH		PART #	#	MM	PART #	PART #	PART #
M8	1,00	1,5D	12,00MM	<b>3521-8.00K</b>	20	8,3	3521-8.00I	3500-HIT11	3500-TB12
M10	1,25	1,5D	15,00MM	<b>3521-10.00K</b>	15	10,3	3521-10.00I	3500-HIT13	3500-TB13
M10	1,00	1,5D	15,00MM	<b>3523-10.00K</b>	15	10,3	3523-10.00I	3500-HIT13	3500-TB13
M11	1,25	1,5D	16,50MM	<b>3521-11.00K</b>	10	11,3	3521-11.00I	3500-HIT14	3500-TB14
M11	1,00	1,5D	16,50MM	<b>3523-11.00K</b>	10	11,3	3523-11.00I	3500-HIT14	3500-TB14
M12	1,50	1,5D	18,00MM	<b>3521-12.00K</b>	10	12,4	3521-12.00I	3500-HIT15	3500-TB15
M12	1,25	1,5D	18,00MM	<b>3523-12.00K</b>	10	12,3	3523-12.00I	3500-HIT15	3500-TB15
M12	1,00	1,5D	18,00MM	<b>3524-12.00K</b>	10	12,3	3524-12.00I	3500-HIT15	3500-TB15
M13	1,50	1,5D	19,50MM	<b>3521-13.00K</b>	10	13,2*	3521-13.00I	3500-HIT15	
M13	1,25	1,5D	19,50MM	<b>3523-13.00K</b>	10	13,2*	3523-13.00I	3500-HIT15	
M14	1,50	1,5D	21,00MM	<b>3521-14.00K</b>	10	14,4*	3521-14.00I	3500-HIT16	
M14	1,25	1,5D	21,00MM	<b>3523-14.00K</b>	10	14,3*	3523-14.00I	3500-HIT16	
M14	1,00	1,5D	21,00MM	<b>3524-14.00K</b>	10	14,3*	3524-14.00I	3500-HIT16	
M15	1,50	1,5D	22,50MM	<b>3521-15.00K</b>	10	15,3*	3521-15.00I	3500-HIT16	
M16	1,50	1,5D	24,00MM	<b>3521-16.00K</b>	10	16,5*	3521-16.00I	3500-HIT18	
M18	2,00	1,5D	27,00MM	<b>3521-18.00K</b>	5	18,5*	3521-18.00I	3500-HIT20	
M18	1,50	1,5D	27,00MM	<b>3523-18.00K</b>	5	18,5*	3523-18.00I	3500-HIT20	
M20	2,00	1,5D	30,00MM	<b>3521-20.00K</b>	5	20,5*	3521-20.00I	3500-HIT21	
M20	1,50	1,5D	30,00MM	<b>3523-20.00K</b>	5	20,5*	3523-20.00I	3500-HIT21	
M22	2,00	1,5D	33,00MM	<b>3521-22.00K</b>	5	22,5*	3521-22.00I	3500-HIT22	
M22	1,50	1,5D	33,00MM	<b>3523-22.00K</b>	5	22,5*	3523-22.00I	3500-HIT22	
M24	2,00	1,5D	36,00MM	<b>3521-24.00K</b>	5	24,5*	3521-24.00I	3500-HIT23	
M24	1,50	1,5D	36,00MM	<b>3523-24.00K</b>	5	24,5*	3523-24.00I	3500-HIT23	
M26	1,50	1,5D	39,00MM	<b>3523-26.00K</b>	5	26,5*	3523-26.00I	3500-HIT24	
M27	2,00	1,5D	40,50MM	<b>3521-27.00K</b>	5	27,5*	3521-27.00I	3500-HIT24	
M27	1,50	1,5D	40,50MM	<b>3523-27.00K</b>	5	27,5*	3523-27.00I	3500-HIT24	
M28	1,50	1,5D	42,00MM	<b>3523-28.00K</b>	5	28,5*	3523-28.00I	3500-HIT24	
M30	2,00	1,5D	45,00MM	<b>3521-30.00K</b>	5	30,5*	3521-30.00I	3500-HIT26	
M30	1,50	1,5D	45,00MM	<b>3523-30.00K</b>	5	30,5*	3523-30.00I	3500-HIT26	
M33	2,00	1,5D	49,50MM	<b>3521-33.00K</b>	5	33,5*	3521-33.00I	3500-HIT26	
M36	3,00	1,5D	54,00MM	<b>3521-36.00K</b>	3	37,0*	3521-36.00I	3500-HIT28	
M36	2,00	1,5D	54,00MM	<b>3523-36.00K</b>	3	36,5*	3523-36.00I	3500-HIT28	
M36	1,50	1,5D	54,00MM	<b>3524-36.00K</b>	3	36,5*	3524-36.00I	3500-HIT28	

\* Tapping drill not included in thread repair kit.



Some large repair kits over 24mm may be supplied with HIM tools (hex installation mandrels) in place of HIT tools (hand installation tools).



**Bulk Free Running Inserts**  
Page 26



**Standard Bolt**

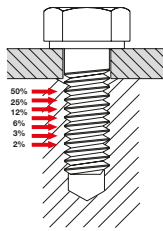

**Bolt with PowerCoil insert**

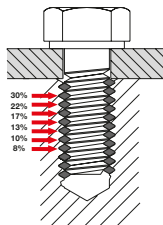

In a conventional threaded joint 75% of the load is placed on the first three threads.

The helical coil design of the PowerCoil Wire Thread Insert allows the shear loading to be transformed into a more desirable radial loading (hoop stress) over the entire length of the insert.

Use of a PowerCoil insert results in a far stronger thread than can be obtained by using conventional drilling or tapping. Improved strength allows designers to select fasteners based on minimum bolt strength and allows the use of smaller diameters and thread lengths - even in magnesium and aluminium alloys.



<b>GROUP</b>	<b>PCRK</b>
INSERT TYPE	WIRE THREAD
INSERT MATERIAL	304 STAINLESS STEEL
STYLE	<b>FREE RUNNING</b>

**UNC**

INSERT					INCLUDED IN KIT					
INCH	TPI	INSTALLED LENGTH	MIL SPEC	PART #	#	MM	PART #	PART #	PART #	
2G	56	1,5D	0,13"	MS122135	<b>3532-2GK</b>	20	2,4	3532-2GI	3500-HIT2	3500-TB2
3G	48	1,5D	0,15"	MS122155	<b>3532-3GK</b>	20	2,7	3532-3GI	3500-HIT3	3500-TB3
4G	40	1,5D	0,17"	MS122116	<b>3532-4GK</b>	20	3,1	3532-4GI	3500-HIT4	3500-TB4
5G	40	1,5D	0,19"	MS122117	<b>3532-5GK</b>	20	3,4	3532-5GI	3500-HIT4	3500-TB4
6G	32	1,5D	0,21"	MS122118	<b>3532-6GK</b>	20	3,8	3532-6GI	3500-HIT5	3500-TB5
8G	32	1,5D	0,25"	MS122119	<b>3532-8GK</b>	20	4,4	3532-8GI	3500-HIT6	3500-TB6
10G	24	1,5D	0,28"	MS122120	<b>3532-10GK</b>	20	5,2	3532-10GI	3500-HIT7	3500-TB8
12G	24	1,5D	0,33"		<b>3532-12GK</b>	20	5,8	3532-12GI	3500-HIT8	3500-TB8
1/4	20	1,5D	0,38"	MS122121	<b>3532-1/4K</b>	20	6,7	3532-1/4I	3500-HIT9	3500-TB9
5/16	18	1,5D	0,47"	MS122122	<b>3532-5/16K</b>	20	8,3	3532-5/16I	3500-HIT10	3500-TB12
3/8	16	1,5D	0,56"	MS122123	<b>3532-3/8K</b>	15	9,9	3532-3/8I	3500-HIT13	3500-TB12
7/16	14	1,5D	0,66"	MS122124	<b>3532-7/16K</b>	10	11,6	3532-7/16I	3500-HIT14	3500-TB14
1/2	13	1,5D	0,75"	MS122125	<b>3532-1/2K</b>	10	13,0	3532-1/2I	3500-HIT15	3500-TB15
9/16	12	1,5D	0,84"	MS122126	<b>3532-9/16K</b>	10	15,0*	3532-9/16I	3500-HIT16	
5/8	11	1,5D	0,94"	MS122127	<b>3532-5/8K</b>	10	16,5*	3532-5/8I	3500-HIT18	
3/4	10	1,5D	1,13"	MS122128	<b>3532-3/4K</b>	5	19,8*	3532-3/4I	3500-HIT20	
7/8	9	1,5D	1,31"	MS122129	<b>3532-7/8K</b>	5	23,0*	3532-7/8I	3500-HIT22	
1	8	1,5D	1,50"	MS122130	<b>3532-1K</b>	5	26,2*	3532-1I	3500-HIT23	
1-1/8	7	1,5D	1,69"	MS122131	<b>3532-1.1/8K</b>	3	29,5*	3532-1.1/8I	3500-HIT25	
1-1/4	7	1,5D	1,88"	MS122132	<b>3532-1.1/4K</b>	3	32,5*	3532-1.1/4I	3500-HIT26	
1-3/8	6	1,5D	2,06"	MS122133	<b>3532-1.3/8K</b>	3	36,0*	3532-1.3/8I	3500-HIT27	
1-1/2	6	1,5D	2,25"	MS122134	<b>3532-1.1/2K</b>	3	39,5*	3532-1.1/2I	3500-HIT28	

**UNF**

INSERT					INCLUDED IN KIT					
INCH	TPI	INSTALLED LENGTH	MIL SPEC	PART #	#	MM	PART #	PART #	PART #	
3G	56	1,5D	0,15"		<b>3534-3GK</b>	20	2,7	3534-3GI	3500-HIT3	3500-TB3
4G	48	1,5D	0,17"		<b>3534-4GK</b>	20	3,0	3534-4GI	3500-HIT4	3500-TB4
6G	40	1,5D	0,21"		<b>3534-6GK</b>	20	3,8	3534-6GI	3500-HIT5	3500-TB5
8G	36	1,5D	0,25"		<b>3534-8GK</b>	20	4,4	3534-8GI	3500-HIT6	3500-TB6
10G	32	1,5D	0,28"		<b>3534-10GK</b>	20	5,1	3534-10GI	3500-HIT8	3500-TB8
12G	28	1,5D	0,32"		<b>3534-12GK</b>	20	5,7	3534-12GI	3500-HIT8	3500-TB8
1/4	28	1,5D	0,38"		<b>3534-1/4K</b>	20	6,7	3534-1/4I	3500-HIT9	3500-TB9
5/16	24	1,5D	0,47"		<b>3534-5/16K</b>	20	8,3	3534-5/16I	3500-HIT11	3500-TB12
3/8	24	1,5D	0,56"		<b>3534-3/8K</b>	15	9,8	3534-3/8I	3500-HIT13	3500-TB13
7/16	16	1,5D	0,66"		<b>3534-7/16-16K</b>	10	11,5	3534-7/16-16I	3500-HIT14	3500-TB14
7/16	20	1,5D	0,66"		<b>3534-7/16K</b>	10	11,5	3534-7/16I	3500-HIT14	3500-TB14
1/2	20	1,5D	0,75"		<b>3534-1/2K</b>	10	13,0	3534-1/2I	3500-HIT15	3500-TB15
9/16	18	1,5D	0,84"		<b>3534-9/16K</b>	10	14,7*	3534-9/16I	3500-HIT16	
5/8	18	1,5D	0,94"		<b>3534-5/8K</b>	10	16,3*	3534-5/8I	3500-HIT18	
3/4	16	1,5D	1,13"		<b>3534-3/4K</b>	5	19,5*	3534-3/4I	3500-HIT21	
7/8	14	1,5D	1,31"		<b>3534-7/8K</b>	5	22,5*	3534-7/8I	3500-HIT22	
1	12	1,5D	1,50"		<b>3534-1K</b>	5	26,0*	3534-1I	3500-HIT23	
1	14	1,5D	1,50"		<b>3535-1K</b>	5	26,0*	3535-1I	3500-HIT23	
1-1/8	12	1,5D	1,69"		<b>3534-1.1/8K</b>	3	29,5*	3534-1.1/8I	3500-HIT25	
1-1/4	12	1,5D	1,88"		<b>3534-1.1/4K</b>	3	32,5*	3534-1.1/4I	3500-HIT26	
1-3/8	12	1,5D	2,06"		<b>3534-1.3/8K</b>	3	35,5*	3534-1.3/8I	3500-HIT27	
1-1/2	12	1,5D	2,25"		<b>3534-1.1/2K</b>	3	38,5*	3534-1.1/2I	3500-HIT28	

\* Tapping drill not included in thread repair kit.



<b>GROUP</b>	<b>PCRK</b>
INSERT TYPE	WIRE THREAD
INSERT MATERIAL	304 STAINLESS STEEL
STYLE	<b>FREE RUNNING</b>

BSW				INSERT						INCLUDED IN KIT				
INCH	TPI	INSTALLED LENGTH		PART #	#	MM	PART #	PART #	PART #					
1/8	40	1,5D	0,19"	3528-1/8K	20	3,4	3528-1/8I	3500-HIT4	3500-TB4					
3/16	24	1,5D	0,28"	3528-3/16K	20	5,0	3528-3/16I	3500-HIT7	3500-TB8					
1/4	20	1,5D	0,38"	3528-1/4K	20	6,7	3528-1/4I	3500-HIT9	3500-TB9					
5/16	18	1,5D	0,47"	3528-5/16K	20	8,3	3528-5/16I	3500-HIT10	3500-TB11					
3/8	16	1,5D	0,56"	3528-3/8K	15	9,9	3528-3/8I	3500-HIT11	3500-TB12					
7/16	14	1,5D	0,66"	3528-7/16K	10	11,5	3528-7/16I	3500-HIT14	3500-TB14					
1/2	12	1,5D	0,75"	3528-1/2K	10	13,0	3528-1/2I	3500-HIT15	3500-TB15					
9/16	12	1,5D	0,84"	3528-9/16K	10	14,8*	3528-9/16I	3500-HIT16						
5/8	11	1,5D	0,94"	3528-5/8K	10	16,7*	3528-5/8I	3500-HIT18						
3/4	10	1,5D	1,13"	3528-3/4K	5	20,0*	3528-3/4I	3500-HIT20						
7/8	9	1,5D	1,31"	3528-7/8K	5	23,2*	3528-7/8I	3500-HIT22						
1	8	1,5D	1,50"	3528-1K	5	26,5*	3528-1I	3500-HIT23						

BSF				INSERT						INCLUDED IN KIT				
INCH	TPI	INSTALLED LENGTH		PART #	#	MM	PART #	PART #	PART #					
3/16	32	1,5D	0,28"	3530-3/16K	20	5,0	3530-3/16I	3500-HIT8	3500-TB6					
1/4	26	1,5D	0,38"	3530-1/4K	20	6,6	3530-1/4I	3500-HIT9	3500-TB9					
5/16	22	1,5D	0,47"	3530-5/16K	20	8,3	3530-5/16I	3500-HIT11	3500-TB11					
3/8	20	1,5D	0,56"	3530-3/8K	15	9,9	3530-3/8I	3500-HIT13	3500-TB12					
7/16	18	1,5D	0,66"	3530-7/16K	10	11,5	3530-7/16I	3500-HIT14	3500-TB14					
1/2	16	1,5D	0,75"	3530-1/2K	10	13,0	3530-1/2I	3500-HIT15	3500-TB15					
9/16	16	1,5D	0,84"	3530-9/16K	10	14,8*	3530-9/16I	3500-HIT16						
5/8	14	1,5D	0,94"	3530-5/8K	10	16,3*	3530-5/8I	3500-HIT18						
3/4	12	1,5D	1,13"	3530-3/4K	5	19,5*	3530-3/4I	3500-HIT20						
7/8	11	1,5D	1,31"	3530-7/8K	5	22,8*	3530-7/8I	3500-HIT22						
1	10	1,5D	1,50"	3530-1K	5	26,2*	3530-1I	3500-HIT23						

BSP				INSERT						INCLUDED IN KIT				
INCH	TPI	INSTALLED LENGTH		PART #	#	MM	PART #	PART #	PART #					
1/8	28	1,5D	0,19"	3546-1/8K	10	10,0*	3546-1/8I	3500-HIT14						
1/4	19	1,5D	0,38"	3546-1/4K	10	13,6*	3546-1/4I	3500-HIT16						
3/8	19	1,5D	0,56"	3546-3/8K	10	17,1*	3546-3/8I	3500-HIT20						
1/2	14	1,5D	0,75"	3546-1/2K	10	21,5*	3546-1/2I	3500-HIT23						
5/8	14	1,5D	0,94"	3546-5/8K	10	23,4*	3546-5/8I	3500-HIT23						
3/4	14	1,5D	1,13"	3546-3/4K	10	27,0*	3546-3/4I	3500-HIT26						
7/8	14	1,5D	1,31"	3546-7/8K	5	30,5*	3546-7/8I	3500-HIT27						
1	11	1,5D	1,50"	3546-1K	5	33,7*	3546-1I	3500-HIT27						

\* Tapping drill not included in thread repair kit.



Some repair kits may be supplied with HIM tools (hex installation mandrels) in place of HIT tools (hand installation tools).



<b>GROUP</b>	<b>PCRK</b>
INSERT TYPE	WIRE THREAD
INSERT MATERIAL	304 STAINLESS STEEL
STYLE	<b>FREE RUNNING</b>



NPT									
INSERT				INCLUDED IN KIT					
INCH	TPI	INSTALLED LENGTH		PART #	#		PART #	PART #	PART #
1/16	27	0,271"		3552-1/16K	10	K*	3552-1/16I	3500-HIT10	
1/8	27	0,273"		3552-1/8K	10	U*	3552-1/8I	3500-HIT13	
1/4	18	0,394"		3552-1/4K	10	31/64*	3552-1/4I	3500-HIT16	
3/8	18	0,407"		3552-3/8K	10	5/8*	3552-3/8I	3500-HIT18	
1/2	14	0,534"		3552-1/2K	10	35/32*	3552-1/2I	3500-HIT22	
3/4	14	0,553"		3552-3/4K	10	63/64*	3552-3/4I	3500-HIT24	
1	11.5	0,661"		3552-1K	10	1-1/4*	3552-1I	3500-HIT27	



Some repair kits may be supplied with HIM tools (hex installation mandrels) in place of HIT tools (hand installation tools).

8-UN									
INSERT				INCLUDED IN KIT					
INCH	TPI	INSTALLED LENGTH		PART #	#	MM	PART #	PART #	PART #
1-1/8	8	1,5D	1,69"	3570-1.1/8K	3	28,5*	3570-1.1/8I	3500-HIT25	
1-1/4	8	1,5D	1,88"	3570-1.1/4K	3	32,0*	3570-1.1/4I	3500-HIT26	
1-3/8	8	1,5D	2,06"	3570-1.3/8K	3	35,0*	3570-1.3/8I	3500-HIT27	
1-1/2	8	1,5D	2,25"	3570-1.1/2K	3	38,0*	3570-1.1/2I	3500-HIT28	
1-5/8	8	1,5D	2,44"	3570-1.5/8K	3	41,0*	3570-1.5/8I	3500-HIT28	
1-3/4	8	1,5D	2,63"	3570-1.3/4K	3	44,5*	3570-1.3/4I	3500-HIT28	
1-7/8	8	1,5D	2,81"	3570-1.7/8K	3	47,5*	3570-1.7/8I	3500-HIT30	
2	8	1,5D	3,00"	3570-2K	3	50,8*	3570-2I	3500-HIT30	



Some repair kits may be supplied with HIM tools (hex installation mandrels) in place of HIT tools (hand installation tools).

BSC									
INSERT				INCLUDED IN KIT					
INCH	TPI	INSTALLED LENGTH		PART #	#	MM	PART #	PART #	PART #
1/4	26	1,5D	0,38"	3560-1/4K	20	6,6	3560-1/4I	3500-HIT10	3500-TB9
5/16	26	1,5D	0,47"	3560-5/16K	20	8,0	3560-5/16I	3500-HIT11	3500-TB12
3/8	26	1,5D	0,56"	3560-3/8K	15	9,8	3560-3/8I	3500-HIT13	3500-TB13
7/16	26	1,5D	0,66"	3560-7/16K	10	11,1	3560-7/16I	3500-HIT14	3500-TB14
1/2	26	1,5D	0,75"	3560-1/2K	10	12,7	3560-1/2I	3500-HIT15	3500-TB15

BA										
INSERT				INCLUDED IN KIT						
	INCH	MM	INCH	INSTALLED LENGTH	PART #	#	MM	PART #	PART #	PART #
0	0,236	6,0	0,0394	1,5D 0,35"	3544-0K	20	6,2	3544-0I	3500-HIT9	3500-TB11
2	0,185	4,7	0,0319	1,5D 0,28"	3544-2K	20	4,9	3544-2I	3500-HIT7	3500-TB8
4	0,142	3,6	0,0260	1,5D 0,21"	3544-4K	20	3,8	3544-4I	3500-HIT5	3500-TB5
6	0,110	2,8	0,0209	1,5D 0,17"	3544-6K	20	2,9	3544-6I	3500-HIT3	3500-TB3

\* Tapping drill not included in thread repair kit.



**MC  
MF**

<b>GROUP</b>	<b>PCRK</b>
INSERT TYPE	WIRE THREAD
INSERT MATERIAL	304 STAINLESS STEEL
STYLE	<b>FREE RUNNING</b>

METRIC COARSE M5-M12				INSERT						INCLUDED IN KIT				
MM	MM	INSTALLED LENGTH		PART #	#	MM	PART #	PART #	PART #					
M5	0,80	1,5D	7,5MM	3520-WK1	25	5,2	3520-5.00I	3500-HIT8	3500-TB8					
M6	1,00	1,5D	9,0MM		25	6,3	3520-6.00I	3500-HIT9	3500-TB9					
M8	1,25	1,5D	12,0MM		25	8,3	3520-8.00I	3500-HIT11	3500-TB12					
M10	1,50	1,5D	15,0MM		25	10,4	3520-10.00I	3500-HIT13	3500-TB13					
M12	1,75	1,5D	18,0MM		10	12,4	3520-12.00I	3500-HIT15	3500-TB15					

METRIC COARSE M6-M12 + M14 SPARK PLUG				INSERT						INCLUDED IN KIT				
MM	MM	INSTALLED LENGTH		PART #	#	MM	PART #	PART #	PART #					
M6	1,00	1,5D	9,0MM	3522-WK4	25	6,3	3520-6.00I	3500-HIT9	3500-TB9					
M8	1,25	1,5D	12,0MM		25	8,3	3520-8.00I	3500-HIT11	3500-TB12					
M10	1,50	1,5D	15,0MM		25	10,4	3520-10.00I	3500-HIT13	3500-TB13					
M12	1,75	1,5D	18,0MM		10	12,4	3520-12.00I	3500-HIT15	3500-TB15					
M14	1,25		8,4MM		5		3522-14.00PN	3500-HIT17						
M14	1,25		12,4MM		5									
M14	1,25		16,4MM		5									



SPARK PLUG				INSERT						INCLUDED IN KIT				
MM	MM	INSTALLED LENGTH		PART #	#	MM	PART #	PART #	PART #					
M10	1,00		0,339"	3522-WK1	5		3522-10.00PN	3500-HIT13	3500-TB13					
			1/2"		5									
			1/2"		5									
M12	1,25		1/2"		5		3522-12.00PN	3500-HIT15	3500-TB15					
			3/4"		5									
			3/4"		5									
M14	1,25		3/8"	5		3522-14.00PN	3500-HIT17							
			1/2"	5										
			3/4"	5										





<b>GROUP</b>	<b>PCRK</b>
INSERT TYPE	WIRE THREAD
INSERT MATERIAL	304 STAINLESS STEEL
STYLE	<b>FREE RUNNING</b>



**UNC  
UNF  
BSW  
BSF**

**UNC 1/4" – UNC 1/2"**

INSERT					INCLUDED IN KIT					
INCH	TPI	INSTALLED LENGTH		MIL SPEC	PART #	#	MM	PART #	PART #	PART #
1/4	20	1,5D	0,38"	MS122121	<b>3532-WK1</b>	25	6,7	3532-1/4I	3500-HIT9	3500-TB9
5/16	18	1,5D	0,47"	MS122122		25	8,3	3532-5/16I	3500-HIT10	3500-TB12
3/8	16	1,5D	0,56"	MS122123		25	9,9	3532-3/8I	3500-HIT13	3500-TB12
7/16	14	1,5D	0,66"	MS122124		10	11,6	3532-7/16I	3500-HIT14	3500-TB14
1/2	13	1,5D	0,75"	MS122125		10	13,0	3532-1/2I	3500-HIT15	3500-TB15

**UNF 1/4" – UNF 1/2"**

INSERT					INCLUDED IN KIT				
INCH	TPI	INSTALLED LENGTH		PART #	#	MM	PART #	PART #	PART #
1/4	28	1,5D	0,38"	<b>3534-WK1</b>	25	6,7	3534-1/4I	3500-HIT9	3500-TB9
5/16	24	1,5D	0,47"		25	8,3	3534-5/16I	3500-HIT11	3500-TB12
3/8	24	1,5D	0,56"		25	9,8	3534-3/8I	3500-HIT13	3500-TB13
7/16	20	1,5D	0,66"		10	11,5	3534-7/16I	3500-HIT14	3500-TB14
1/2	20	1,5D	0,75"		10	13,0	3534-1/2I	3500-HIT15	3500-TB15

**BSW 1/4" – BSW 1/2"**

INSERT					INCLUDED IN KIT				
INCH	TPI	INSTALLED LENGTH		PART #	#	MM	PART #	PART #	PART #
1/4	20	1,5D	0,38"	<b>3528-WK1</b>	25	6,7	3528-1/4I	3500-HIT9	3500-TB9
5/16	18	1,5D	0,47"		25	8,3	3528-5/16I	3500-HIT10	3500-TB11
3/8	16	1,5D	0,56"		25	9,9	3528-3/8I	3500-HIT11	3500-TB12
7/16	14	1,5D	0,66"		10	11,5	3528-7/16I	3500-HIT14	3500-TB14
1/2	12	1,5D	0,75"		10	13,0	3528-1/2I	3500-HIT15	3500-TB15





**BSF 1/4" – BSF 1/2"**

INSERT					INCLUDED IN KIT				
INCH	TPI	INSTALLED LENGTH		PART #	#	MM	PART #	PART #	PART #
1/4	26	1,5D	0,38"	<b>3530-WK1</b>	25	6,6	3530-1/4I	3500-HIT9	3500-TB9
5/16	22	1,5D	0,47"		25	8,3	3530-5/16I	3500-HIT11	3500-TB11
3/8	20	1,5D	0,56"		25	9,9	3530-3/8I	3500-HIT13	3500-TB12
7/16	18	1,5D	0,66"		10	11,5	3530-7/16I	3500-HIT14	3500-TB14
1/2	16	1,5D	0,75"		10	13,0	3530-1/2I	3500-HIT15	3500-TB15



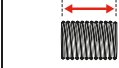

<b>GROUP</b>	<b>PCR/P</b>
INSERT TYPE	WIRE THREAD
INSERT MATERIAL	304 STAINLESS STEEL
STYLE	<b>FREE RUNNING</b>

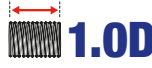
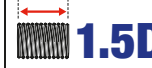
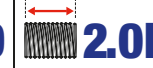
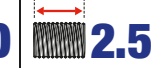
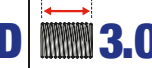
METRIC COARSE				FREE RUNNING					
INSERT				FREE RUNNING					
									
MM	MM	INSTALLED LENGTH	#	PART #	PART #	PART #	PART #	PART #	
M2	0,40	1,0D	2,00MM	10	3520-2.00X1.0DP				
M2	0,40	1,5D	3,00MM	10		3520-2.00X1.5DP			
M2	0,40	2,0D	4,00MM	10			3520-2.00X2.0DP		
M2.2	0,45	1,0D	2,20MM	10	3520-2.20X1.0DP				
M2.2	0,45	1,5D	3,30MM	10		3520-2.20X1.5DP			
M2.2	0,45	2,0D	4,40MM	10			3520-2.20X2.0DP		
M2.5	0,45	1,0D	2,50MM	10	3520-2.50X1.0DP				
M2.5	0,45	1,5D	3,75MM	10		3520-2.50X1.5DP			
M2.5	0,45	2,0D	5,00MM	10			3520-2.50X2.0DP		
M3	0,50	1,0D	3,00MM	10	3520-3.00X1.0DP				
M3	0,50	1,5D	4,50MM	10		3520-3.00X1.5DP			
M3	0,50	2,0D	6,00MM	10			3520-3.00X2.0DP		
M3	0,50	2,5D	7,50MM	10				3520-3.00X2.5DP	
M3.5	0,60	1,0D	3,50MM	10	3520-3.50X1.0DP				
M3.5	0,60	1,5D	5,25MM	10		3520-3.50X1.5DP			
M3.5	0,60	2,0D	7,00MM	10			3520-3.50X2.0DP		
M4	0,70	1,0D	4,00MM	10	3520-4.00X1.0DP				
M4	0,70	1,5D	6,00MM	10		3520-4.00X1.5DP			
M4	0,70	2,0D	8,00MM	10			3520-4.00X2.0DP		
M4	0,70	2,5D	10,00MM	10				3520-4.00X2.5DP	
M4	0,70	3,0D	12,00MM	10				3520-4.00X3.0DP	
M5	0,80	1,0D	5,00MM	10	3520-5.00X1.0DP				
M5	0,80	1,5D	7,50MM	10		3520-5.00X1.5DP			
M5	0,80	2,0D	10,00MM	10			3520-5.00X2.0DP		
M6	1,00	1,0D	6,00MM	10	3520-6.00X1.0DP				
M6	1,00	1,5D	9,00MM	10		3520-6.00X1.5DP			
M6	1,00	2,0D	12,00MM	10			3520-6.00X2.0DP		
M6	1,00	2,5D	15,00MM	10				3520-6.00X2.5DP	
M6	1,00	3,0D	18,00MM	10				3520-6.00X3.0DP	
M7	1,00	1,0D	7,00MM	10	3520-7.00X1.0DP				
M7	1,00	1,5D	10,50MM	10		3520-7.00X1.5DP			
M7	1,00	2,0D	14,00MM	10			3520-7.00X2.0DP		
M7	1,00	3,0D	21,00MM	10				3520-7.00X3.0DP	
M8	1,25	1,0D	8,00MM	10	3520-8.00X1.0DP				
M8	1,25	1,5D	12,00MM	10		3520-8.00X1.5DP			
M8	1,25	2,0D	16,00MM	10			3520-8.00X2.0DP		
M8	1,25	2,5D	20,00MM	10				3520-8.00X2.5DP	
M8	1,25	3,0D	24,00MM	10				3520-8.00X3.0DP	
M9	1,25	1,0D	9,00MM	10	3520-9.00X1.0DP				
M9	1,25	1,5D	13,50MM	10		3520-9.00X1.5DP			
M9	1,25	2,0D	18,00MM	10			3520-9.00X2.0DP		
M9	1,25	3,0D	27,00MM	10				3520-9.00X3.0DP	
M10	1,50	1,0D	10,00MM	10	3520-10.00X1.0DP				
M10	1,50	1,5D	15,00MM	10		3520-10.00X1.5DP			
M10	1,50	2,0D	20,00MM	10			3520-10.00X2.0DP		
M10	1,50	2,5D	25,00MM	10				3520-10.00X2.5DP	
M10	1,50	3,0D	30,00MM	10				3520-10.00X3.0DP	
M11	1,50	1,0D	11,00MM	10	3520-11.00X1.0DP				
M11	1,50	1,5D	16,50MM	10		3520-11.00X1.5DP			
M11	1,50	2,0D	22,00MM	10			3520-11.00X2.0DP		











<b>GROUP</b>	<b>PCRP</b>
INSERT TYPE	WIRE THREAD
INSERT MATERIAL	304 STAINLESS STEEL
STYLE	<b>FREE RUNNING</b>



METRIC COARSE								
INSERT			FREE RUNNING					
MM	MM	INSTALLED LENGTH	#	PART #	PART #	PART #	PART #	PART #
M12	1,75	1,0D	12,00MM	10	3520-12.00X1.0DP			
M12	1,75	1,5D	18,00MM	10		3520-12.00X1.5DP		
M12	1,75	2,0D	24,00MM	10			3520-12.00X2.0DP	
M12	1,75	2,5D	30,00MM	10				3520-12.00X2.5DP
M12	1,75	3,0D	36,00MM	10				3520-12.00X3.0DP
M13	1,75	1,0D	13,00MM	5	3520-13.00X1.0DP			
M13	1,75	1,5D	19,50MM	5		3520-13.00X1.5DP		
M13	1,75	2,0D	26,00MM	5			3520-13.00X2.0DP	
M14	2,00	1,0D	14,00MM	5	3520-14.00X1.0DP			
M14	2,00	1,5D	21,00MM	5		3520-14.00X1.5DP		
M14	2,00	2,0D	28,00MM	5			3520-14.00X2.0DP	
M14	2,00	2,5D	35,00MM	5				3520-14.00X2.5DP
M14	2,00	3,0D	42,00MM	5				3520-14.00X3.0DP
M15	2,00	1,0D	15,00MM	5	3520-15.00X1.0DP			
M15	2,00	1,5D	22,50MM	5		3520-15.00X1.5DP		
M15	2,00	2,0D	30,00MM	5			3520-15.00X2.0DP	
M16	2,00	1,0D	16,00MM	5	3520-16.00X1.0DP			
M16	2,00	1,5D	24,00MM	5		3520-16.00X1.5DP		
M16	2,00	2,0D	32,00MM	5			3520-16.00X2.0DP	
M16	2,00	2,5D	40,00MM	5				3520-16.00X2.5DP
M18	2,50	1,0D	18,00MM	5	3520-18.00X1.0DP			
M18	2,50	1,5D	27,00MM	5		3520-18.00X1.5DP		
M18	2,50	2,0D	36,00MM	5			3520-18.00X2.0DP	
M20	2,50	1,0D	20,00MM	5	3520-20.00X1.0DP			
M20	2,50	1,5D	30,00MM	5		3520-20.00X1.5DP		
M20	2,50	2,0D	40,00MM	5			3520-20.00X2.0DP	
M22	2,50	1,0D	22,00MM	3	3520-22.00X1.0DP			
M22	2,50	1,5D	33,00MM	3		3520-22.00X1.5DP		
M22	2,50	2,0D	44,00MM	3			3520-22.00X2.0DP	
M24	3,00	1,0D	24,00MM	3	3520-24.00X1.0DP			
M24	3,00	1,5D	36,00MM	3		3520-24.00X1.5DP		
M24	3,00	2,0D	48,00MM	3			3520-24.00X2.0DP	
M24	3,00	2,5D	60,00MM	3				3520-24.00X2.5DP



GROUP	PCRP
INSERT TYPE	WIRE THREAD
INSERT MATERIAL	304 STAINLESS STEEL
STYLE	<b>FREE RUNNING</b>

METRIC FINE				FREE RUNNING			
INSERT			FREE RUNNING				
							
MM	MM	INSTALLED LENGTH	#	PART #	PART #	PART #	
M6	0,75	1,0D	6,00MM	10	3521-6.00X1.0DP		
M6	0,75	1,5D	9,00MM	10		3521-6.00X1.5DP	
M6	0,75	2,0D	12,00MM	10			3521-6.00X2.0DP
M8	1,00	1,0D	8,00MM	10	3521-8.00X1.0DP		
M8	1,00	1,5D	12,00MM	10		3521-8.00X1.5DP	
M8	1,00	2,0D	16,00MM	10			3521-8.00X2.0DP
M8	0,75	1,0D	8,00MM	10	3523-8.00X1.0DP		
M8	0,75	1,5D	12,00MM	10		3523-8.00X1.5DP	
M8	0,75	2,0D	16,00MM	10			3523-8.00X2.0DP
M9	1,00	1,0D	9,00MM	10	3521-9.00X1.0DP		
M9	1,00	1,5D	13,50MM	10		3521-9.00X1.5DP	
M9	1,00	2,0D	18,00MM	10			3521-9.00X2.0DP
M10	1,25	1,0D	10,00MM	10	3521-10.00X1.0DP		
M10	1,25	1,5D	15,00MM	10		3521-10.00X1.5DP	
M10	1,25	2,0D	20,00MM	10			3521-10.00X2.0DP
M10	1,00	1,0D	10,00MM	10	3523-10.00X1.0DP		
M10	1,00	1,5D	15,00MM	10		3523-10.00X1.5DP	
M10	1,00	2,0D	20,00MM	10			3523-10.00X2.0DP
M11	1,25	1,0D	11,00MM	10	3521-11.00X1.0DP		
M11	1,25	1,5D	16,50MM	10		3521-11.00X1.5DP	
M11	1,25	2,0D	22,00MM	10			3521-11.00X2.0DP
M11	1,00	1,0D	11,00MM	10	3523-11.00X1.0DP		
M11	1,00	1,5D	16,50MM	10		3523-11.00X1.5DP	
M11	1,00	2,0D	22,00MM	10			3523-11.00X2.0DP
M12	1,50	1,0D	12,00MM	10	3521-12.00X1.0DP		
M12	1,50	1,5D	18,00MM	10		3521-12.00X1.5DP	
M12	1,50	2,0D	24,00MM	10			3521-12.00X2.0DP
M12	1,25	1,0D	12,00MM	10	3523-12.00X1.0DP		
M12	1,25	1,5D	18,00MM	10		3523-12.00X1.5DP	
M12	1,25	2,0D	24,00MM	10			3523-12.00X2.0DP
M12	1,00	1,0D	12,00MM	10	3524-12.00X1.0DP		
M12	1,00	1,5D	18,00MM	10		3524-12.00X1.5DP	
M12	1,00	2,0D	24,00MM	10			3524-12.00X2.0DP
M13	1,50	1,0D	13,00MM	5	3521-13.00X1.0DP		
M13	1,50	1,5D	19,50MM	5		3521-13.00X1.5DP	
M13	1,50	2,0D	26,00MM	5			3521-13.00X2.0DP
M13	1,25	1,0D	13,00MM	5	3523-13.00X1.0DP		
M13	1,25	1,5D	19,50MM	5		3523-13.00X1.5DP	
M13	1,25	2,0D	26,00MM	5			3523-13.00X2.0DP
M14	1,50	1,0D	14,00MM	5	3521-14.00X1.0DP		
M14	1,50	1,5D	21,00MM	5		3521-14.00X1.5DP	
M14	1,50	2,0D	28,00MM	5			3521-14.00X2.0DP
M14	1,25	1,0D	14,00MM	5	3523-14.00X1.0DP		
M14	1,25	1,5D	21,00MM	5		3523-14.00X1.5DP	
M14	1,25	2,0D	28,00MM	5			3523-14.00X2.0DP
M14	1,00	1,0D	14,00MM	5	3524-14.00X1.0DP		
M14	1,00	1,5D	21,00MM	5		3524-14.00X1.5DP	
M14	1,00	2,0D	28,00MM	5			3524-14.00X2.0DP
M15	1,50	1,0D	15,00MM	5	3521-15.00X1.0DP		
M15	1,50	1,5D	22,50MM	5		3521-15.00X1.5DP	
M15	1,50	2,0D	30,00MM	5			3521-15.00X2.0DP



<b>GROUP</b>	<b>PCRP</b>
INSERT TYPE	WIRE THREAD
INSERT MATERIAL	304 STAINLESS STEEL
STYLE	<b>FREE RUNNING</b>

METRIC FINE						
INSERT			FREE RUNNING			
MM	MM	INSTALLED LENGTH	#	PART #	PART #	PART #
<b>M16</b>	1,50	<b>1,0D</b>	16,00MM	5	3521-16.00X1.0DP	
<b>M16</b>	1,50	<b>1,5D</b>	24,00MM	5		3521-16.00X1.5DP
<b>M16</b>	1,50	<b>2,0D</b>	32,00MM	5		3521-16.00X2.0DP
<b>M18</b>	2,00	<b>1,0D</b>	18,00MM	5	3521-18.00X1.0DP	
<b>M18</b>	2,00	<b>1,5D</b>	27,00MM	5		3521-18.00X1.5DP
<b>M18</b>	2,00	<b>2,0D</b>	36,00MM	5		3521-18.00X2.0DP
<b>M18</b>	1,50	<b>1,0D</b>	18,00MM	5	3523-18.00X1.0DP	
<b>M18</b>	1,50	<b>1,5D</b>	27,00MM	5		3523-18.00X1.5DP
<b>M18</b>	1,50	<b>2,0D</b>	36,00MM	5		3523-18.00X2.0DP
<b>M20</b>	2,00	<b>1,0D</b>	20,00MM	5	3521-20.00X1.0DP	
<b>M20</b>	2,00	<b>1,5D</b>	30,00MM	5		3521-20.00X1.5DP
<b>M20</b>	2,00	<b>2,0D</b>	40,00MM	5		3521-20.00X2.0DP
<b>M20</b>	1,50	<b>1,0D</b>	20,00MM	5	3523-20.00X1.0DP	
<b>M20</b>	1,50	<b>1,5D</b>	30,00MM	5		3523-20.00X1.5DP
<b>M20</b>	1,50	<b>2,0D</b>	40,00MM	5		3523-20.00X2.0DP
<b>M20</b>	1,25	<b>1,5D</b>	30,00MM	5		3524-20.00X1.5DP
<b>M22</b>	2,00	<b>1,0D</b>	22,00MM	3	3521-22.00X1.0DP	
<b>M22</b>	2,00	<b>1,5D</b>	33,00MM	3		3521-22.00X1.5DP
<b>M22</b>	2,00	<b>2,0D</b>	44,00MM	3		3521-22.00X2.0DP
<b>M22</b>	1,50	<b>1,0D</b>	22,00MM	3	3523-22.00X1.0DP	
<b>M22</b>	1,50	<b>1,5D</b>	33,00MM	3		3523-22.00X1.5DP
<b>M22</b>	1,50	<b>2,0D</b>	44,00MM	3		3523-22.00X2.0DP
<b>M24</b>	2,00	<b>1,0D</b>	24,00MM	3	3521-24.00X1.0DP	
<b>M24</b>	2,00	<b>1,5D</b>	36,00MM	3		3521-24.00X1.5DP
<b>M24</b>	2,00	<b>2,0D</b>	48,00MM	3		3521-24.00X2.0DP
<b>M24</b>	1,50	<b>1,0D</b>	24,00MM	3	3523-24.00X1.0DP	
<b>M24</b>	1,50	<b>1,5D</b>	36,00MM	3		3523-24.00X1.5DP
<b>M24</b>	1,50	<b>2,0D</b>	48,00MM	3		3523-24.00X2.0DP





<b>GROUP</b>	<b>PCRP</b>
INSERT TYPE	WIRE THREAD
INSERT MATERIAL	304 STAINLESS STEEL
STYLE	<b>FREE RUNNING</b>

SPARK PLUG			FREE RUNNING			
INSERT			FREE RUNNING			
MM	MM	INSTALLED LENGTH	#	PART #	PART #	PART #
M10	1,00	<b>0,339"</b>	10	3522-10.00X.339P		
M10	1,00	<b>1/2"</b>	10		3522-10.00X1/2P	
M12	1,25	<b>1/2"</b>	10		3522-12.00X1/2P	
M12	1,25	<b>3/4"</b>	10			3522-12.00X3/4P
M18	1,50	<b>1/2"</b>	5		3522-18.00X1/2P	

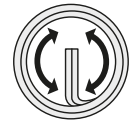

SPARK PLUG			FREE RUNNING				
INSERT			FREE RUNNING				
MM	MM	INSTALLED LENGTH	#	PART #	PART #	PART #	PART #
M14	1,25	<b>3/8"</b>	10	3522-14.00X3/8P			
M14	1,25	<b>7/16"</b>	10		3522-14.00X7/16P		
M14	1,25	<b>1/2"</b>	10			3522-14.00X1/2P	
M14	1,25	<b>3/4"</b>	10				3522-14.00X3/4P

SPARK PLUG			FREE RUNNING			
INSERT			FREE RUNNING			
MM	MM	INSTALLED LENGTH	#	PART #	PART #	PART #
M14	1,25	<b>8,4MM</b>	10	3522-14.00X8.4P		
M14	1,25	<b>12,4MM</b>	10		3522-14.00X12.4P	
M14	1,25	<b>16,4MM</b>	10			3522-14.00X16.4P



<b>GROUP</b>	<b>PCRP</b>
INSERT TYPE	WIRE THREAD
INSERT MATERIAL	304 STAINLESS STEEL
STYLE	<b>FREE RUNNING</b>



UNC								
INSERT				FREE RUNNING MIL SPEC				
INCH	TPI	INSTALLED LENGTH	#	MS	1.0D	1.5D	2.0D	
					PART #	PART #	PART #	
2G	56	1,0D	0,09"	10	MS122095	3532-2GX1.0DP		
2G	56	1,5D	0,13"	10	MS122135		3532-2GX1.5DP	
2G	56	2,0D	0,17"	10	MS122175			3532-2GX2.0DP
3G	48	1,0D	0,10"	10	MS122115	3532-3GX1.0DP		
3G	48	1,5D	0,15"	10	MS122155		3532-3GX1.5DP	
3G	48	2,0D	0,20"	10	MS122195			3532-3GX2.0DP
4G	40	1,0D	0,11"	10	MS122076	3532-4GX1.0DP		
4G	40	1,5D	0,17"	10	MS122116		3532-4GX1.5DP	
4G	40	2,0D	0,22"	10	MS122156			3532-4GX2.0DP
5G	40	1,0D	0,13"	10	MS122077	3532-5GX1.0DP		
5G	40	1,5D	0,19"	10	MS122117		3532-5GX1.5DP	
5G	40	2,0D	0,25"	10	MS122157			3532-5GX2.0DP
6G	32	1,0D	0,14"	10	MS122078	3532-6GX1.0DP		
6G	32	1,5D	0,21"	10	MS122118		3532-6GX1.5DP	
6G	32	2,0D	0,28"	10	MS122158			3532-6GX2.0DP
8G	32	1,0D	0,16"	10	MS122079	3532-8GX1.0DP		
8G	32	1,5D	0,25"	10	MS122119		3532-8GX1.5DP	
8G	32	2,0D	0,33"	10	MS122159			3532-8GX2.0DP
10G	24	1,0D	0,19"	10	MS122080	3532-10GX1.0DP		
10G	24	1,5D	0,29"	10	MS122120		3532-10GX1.5DP	
10G	24	2,0D	0,38"	10	MS122160			3532-10GX2.0DP
12G	24	1,0D	0,22"	10		3532-12GX1.0DP		
12G	24	1,5D	0,32"	10			3532-12GX1.5DP	
12G	24	2,0D	0,43"	10				3532-12GX2.0DP
1/4	20	1,0D	0,25"	10	MS122081	3532-1/4X1.0DP		
1/4	20	1,5D	0,38"	10	MS122121		3532-1/4X1.5DP	
1/4	20	2,0D	0,50"	10	MS122161			3532-1/4X2.0DP
5/16	18	1,0D	0,31"	10	MS122082	3532-5/16X1.0DP		
5/16	18	1,5D	0,47"	10	MS122122		3532-5/16X1.5DP	
5/16	18	2,0D	0,63"	10	MS122162			3532-5/16X2.0DP
3/8	16	1,0D	0,38"	10	MS122083	3532-3/8X1.0DP		
3/8	16	1,5D	0,56"	10	MS122123		3532-3/8X1.5DP	
3/8	16	2,0D	0,75"	10	MS122163			3532-3/8X2.0DP
7/16	14	1,0D	0,44"	10	MS122084	3532-7/16X1.0DP		
7/16	14	1,5D	0,66"	10	MS122124		3532-7/16X1.5DP	
7/16	14	2,0D	0,88"	10	MS122164			3532-7/16X2.0DP
1/2	13	1,0D	0,50"	10	MS122085	3532-1/2X1.0DP		
1/2	13	1,5D	0,75"	10	MS122125		3532-1/2X1.5DP	
1/2	13	2,0D	1,00"	10	MS122165			3532-1/2X2.0DP
9/16	12	1,0D	0,56"	5	MS122086	3532-9/16X1.0DP		
9/16	12	1,5D	0,84"	5	MS122126		3532-9/16X1.5DP	
9/16	12	2,0D	1,13"	5	MS122166			3532-9/16X2.0DP
5/8	11	1,0D	0,63"	5	MS122087	3532-5/8X1.0DP		
5/8	11	1,5D	0,94"	5	MS122127		3532-5/8X1.5DP	
5/8	11	2,0D	1,25"	5	MS122167			3532-5/8X2.0DP
3/4	10	1,0D	0,75"	5	MS122088	3532-3/4X1.0DP		
3/4	10	1,5D	1,13"	5	MS122128		3532-3/4X1.5DP	
3/4	10	2,0D	1,50"	5	MS122168			3532-3/4X2.0DP
7/8	9	1,0D	0,88"	3	MS122089	3532-7/8X1.0DP		
7/8	9	1,5D	1,31"	3	MS122129		3532-7/8X1.5DP	
7/8	9	2,0D	1,75"	3	MS122169			3532-7/8X2.0DP
1	8	1,0D	1,00"	3	MS122090	3532-1X1.0DP		
1	8	1,5D	1,50"	3	MS122130		3532-1X1.5DP	
1	8	2,0D	2,00"	3	MS122170			3532-1X2.0DP



<b>GROUP</b>	<b>PCRP</b>
INSERT TYPE	WIRE THREAD
INSERT MATERIAL	304 STAINLESS STEEL
STYLE	<b>FREE RUNNING</b>

UNF		INSERT		FREE RUNNING			
INCH	TPI	INSTALLED LENGTH		#	1.0D	1.5D	2.0D
					PART #	PART #	PART #
3G	56	1,0D	0,10"	10	3534-3GX1.0DP		
3G	56	1,5D	0,15"	10		3534-3GX1.5DP	
3G	56	2,0D	0,20"	10			3534-3GX2.0DP
4G	48	1,0D	0,11"	10	3534-4GX1.0DP		
4G	48	1,5D	0,17"	10		3534-4GX1.5DP	
4G	48	2,0D	0,22"	10			3534-4GX2.0DP
6G	40	1,0D	0,14"	10	3534-6GX1.0DP		
6G	40	1,5D	0,21"	10		3534-6GX1.5DP	
6G	40	2,0D	0,28"	10			3534-6GX2.0DP
8G	36	1,0D	0,16"	10	3534-8GX1.0DP		
8G	36	1,5D	0,25"	10		3534-8GX1.5DP	
8G	36	2,0D	0,33"	10			3534-8GX2.0DP
10G	32	1,0D	0,19"	10	3534-10GX1.0DP		
10G	32	1,5D	0,29"	10		3534-10GX1.5DP	
10G	32	2,0D	0,38"	10			3534-10GX2.0DP
12G	28	1,0D	0,22"	10	3534-12GX1.0DP		
12G	28	1,5D	0,32"	10		3534-12GX1.5DP	
12G	28	2,0D	0,43"	10			3534-12GX2.0DP
1/4	32	1,5D	0,38"	10		3535-1/4X1.5DP	
1/4	28	1,0D	0,25"	10	3534-1/4X1.0DP		
1/4	28	1,5D	0,38"	10		3534-1/4X1.5DP	
1/4	28	2,0D	0,50"	10			3534-1/4X2.0DP
1/4	24	1,0D	0,25"	10	3534-1/4X1.0DP		
1/4	24	1,5D	0,38"	10		3534-1/4X1.5DP	
1/4	24	2,0D	0,50"	10			3534-1/4X2.0DP
5/16	24	1,0D	0,31"	10	3534-5/16X1.0DP		
5/16	24	1,5D	0,47"	10		3534-5/16X1.5DP	
5/16	24	2,0D	0,62"	10			3534-5/16X2.0DP
3/8	24	1,0D	0,38"	10	3534-3/8X1.0DP		
3/8	24	1,5D	0,57"	10		3534-3/8X1.5DP	
3/8	24	2,0D	0,76"	10			3534-3/8X2.0DP
7/16	20	1,0D	0,44"	10	3534-7/16X1.0DP		
7/16	20	1,5D	0,66"	10		3534-7/16X1.5DP	
7/16	20	2,0D	0,88"	10			3534-7/16X2.0DP
7/16	16	1,5D	0,66"	10		3534-7/16X1.5DP	
1/2	20	1,0D	0,50"	10	3534-1/2X1.0DP		
1/2	20	1,5D	0,75"	10		3534-1/2X1.5DP	
1/2	20	2,0D	1,00"	10			3534-1/2X2.0DP
9/16	18	1,0D	0,56"	5	3534-9/16X1.0DP		
9/16	18	1,5D	0,84"	5		3534-9/16X1.5DP	
9/16	18	2,0D	1,12"	5			3534-9/16X2.0DP
5/8	18	1,0D	0,63"	5	3534-5/8X1.0DP		
5/8	18	1,5D	0,95"	5		3534-5/8X1.5DP	
5/8	18	2,0D	1,26"	5			3534-5/8X2.0DP
3/4	16	1,0D	0,75"	5	3534-3/4X1.0DP		
3/4	16	1,5D	1,13"	5		3534-3/4X1.5DP	
3/4	16	2,0D	1,50"	5			3534-3/4X2.0DP
7/8	14	1,0D	0,88"	3	3534-7/8X1.0DP		
7/8	14	1,5D	1,32"	3		3534-7/8X1.5DP	
7/8	14	2,0D	1,76"	3			3534-7/8X2.0DP
1	14	1,0D	1,00"	3	3535-1X1.0DP		
1	14	1,5D	1,50"	3		3535-1X1.5DP	
1	14	2,0D	2,00"	3			3535-1X2.0DP
1	12	1,0D	1,00"	3	3534-1X1.0DP		
1	12	1,5D	1,50"	3		3534-1X1.5DP	
1	12	2,0D	2,00"	3			3534-1X2.0DP



<b>GROUP</b>	<b>PCRP</b>
INSERT TYPE	WIRE THREAD
INSERT MATERIAL	304 STAINLESS STEEL
STYLE	<b>FREE RUNNING</b>



BSW				FREE RUNNING		
INSERT						
INCH	TPI	INSTALLED LENGTH	#	1.0D	1.5D	2.0D
				PART #	PART #	PART #
1/8	40	1,0D	0,13"	10	3528-1/8X1.0DP	
1/8	40	1,5D	0,20"	10		3528-1/8X1.5DP
1/8	40	2,0D	0,26"	10		3528-1/8X2.0DP
3/16	24	1,0D	0,19"	10	3528-3/16X1.0DP	
3/16	24	1,5D	0,29"	10		3528-3/16X1.5DP
3/16	24	2,0D	0,38"	10		3528-3/16X2.0DP
1/4	20	1,0D	0,25"	10	3528-1/4X1.0DP	
1/4	20	1,5D	0,38"	10		3528-1/4X1.5DP
1/4	20	2,0D	0,50"	10		3528-1/4X2.0DP
5/16	18	1,0D	0,31"	10	3528-5/16X1.0DP	
5/16	18	1,5D	0,47"	10		3528-5/16X1.5DP
5/16	18	2,0D	0,62"	10		3528-5/16X2.0DP
3/8	16	1,0D	0,38"	10	3528-3/8X1.0DP	
3/8	16	1,5D	0,57"	10		3528-3/8X1.5DP
3/8	16	2,0D	0,76"	10		3528-3/8X2.0DP
7/16	14	1,0D	0,44"	10	3528-7/16X1.0DP	
7/16	14	1,5D	0,66"	10		3528-7/16X1.5DP
7/16	14	2,0D	0,88"	10		3528-7/16X2.0DP
1/2	12	1,0D	0,50"	10	3528-1/2X1.0DP	
1/2	12	1,5D	0,75"	10		3528-1/2X1.5DP
1/2	12	2,0D	1,00"	10		3528-1/2X2.0DP
9/16	12	1,0D	0,56"	5	3528-9/16X1.0DP	
9/16	12	1,5D	0,84"	5		3528-9/16X1.5DP
9/16	12	2,0D	1,12"	5		3528-9/16X2.0DP
5/8	11	1,0D	0,63"	5	3528-5/8X1.0DP	
5/8	11	1,5D	0,95"	5		3528-5/8X1.5DP
5/8	11	2,0D	1,26"	5		3528-5/8X2.0DP
3/4	10	1,0D	0,75"	5	3528-3/4X1.0DP	
3/4	10	1,5D	1,13"	5		3528-3/4X1.5DP
3/4	10	2,0D	1,50"	5		3528-3/4X2.0DP
7/8	9	1,0D	0,88"	3	3528-7/8X1.0DP	
7/8	9	1,5D	1,32"	3		3528-7/8X1.5DP
7/8	9	2,0D	1,76"	3		3528-7/8X2.0DP
1	8	1,0D	1,00"	3	3528-1X1.0DP	
1	8	1,5D	1,50"	3		3528-1X1.5DP
1	8	2,0D	2,00"	3		3528-1X2.0DP





<b>GROUP</b>	<b>PCRP</b>
INSERT TYPE	WIRE THREAD
INSERT MATERIAL	304 STAINLESS STEEL
STYLE	<b>FREE RUNNING</b>



BSF							
INSERT				FREE RUNNING			
INCH	TPI	INSTALLED LENGTH		#	1.0D	1.5D	2.0D
					PART #	PART #	PART #
3/16	32	1,0D	0,19"	10	3530-3/16X1.0DP		
3/16	32	1,5D	0,29"	10		3530-3/16X1.5DP	
3/16	32	2,0D	0,38"	10			3530-3/16X2.0DP
1/4	26	1,0D	0,25"	10	3530-1/4X1.0DP		
1/4	26	1,5D	0,38"	10		3530-1/4X1.5DP	
1/4	26	2,0D	0,50"	10			3530-1/4X2.0DP
5/16	22	1,0D	0,31"	10	3530-5/16X1.0DP		
5/16	22	1,5D	0,47"	10		3530-5/16X1.5DP	
5/16	22	2,0D	0,62"	10			3530-5/16X2.0DP
3/8	20	1,0D	0,38"	10	3530-3/8X1.0DP		
3/8	20	1,5D	0,57"	10		3530-3/8X1.5DP	
3/8	20	2,0D	0,76"	10			3530-3/8X2.0DP
7/16	18	1,0D	0,44"	10	3530-7/16X1.0DP		
7/16	18	1,5D	0,66"	10		3530-7/16X1.5DP	
7/16	18	2,0D	0,88"	10			3530-7/16X2.0DP
1/2	16	1,0D	0,50"	10	3530-1/2X1.0DP		
1/2	16	1,5D	0,75"	10		3530-1/2X1.5DP	
1/2	16	2,0D	1,00"	10			3530-1/2X2.0DP
9/16	16	1,0D	0,56"	5	3530-9/16X1.0DP		
9/16	16	1,5D	0,84"	5		3530-9/16X1.5DP	
9/16	16	2,0D	1,12"	5			3530-9/16X2.0DP
5/8	14	1,0D	0,63"	5	3530-5/8X1.0DP		
5/8	14	1,5D	0,95"	5		3530-5/8X1.5DP	
5/8	14	2,0D	1,26"	5			3530-5/8X2.0DP
3/4	12	1,0D	0,75"	5	3530-3/4X1.0DP		
3/4	12	1,5D	1,13"	5		3530-3/4X1.5DP	
3/4	12	2,0D	1,50"	5			3530-3/4X2.0DP
7/8	11	1,0D	0,88"	3	3530-7/8X1.0DP		
7/8	11	1,5D	1,32"	3		3530-7/8X1.5DP	
7/8	11	2,0D	1,76"	3			3530-7/8X2.0DP
1	10	1,0D	1,00"	3	3530-1X1.0DP		
1	10	1,5D	1,50"	3		3530-1X1.5DP	
1	10	2,0D	2,00"	3			3530-1X2.0DP



<b>GROUP</b>	<b>PCRP</b>
<b>INSERT TYPE</b>	WIRE THREAD
<b>INSERT MATERIAL</b>	304 STAINLESS STEEL
<b>STYLE</b>	<b>FREE RUNNING</b>



**BSC  
BSP  
NPT**

BSC		INSERT		FREE RUNNING		
INCH	TPI	INSTALLED LENGTH	#	1.0D PART #	1.5D PART #	2.0D PART #
1/4	26	1,5D 0,38"	10		3560-1/4X1.5DP	
5/16	26	1,5D 0,47"	10		3560-5/16X1.5DP	
3/8	26	1,5D 0,56"	10		3560-3/8X1.5DP	
7/16	26	1,5D 0,66"	10		3560-7/16X1.5DP	
1/2	26	1,5D 0,75"	10		3560-1/2X1.5DP	

BSP		INSERT		FREE RUNNING		
INCH	TPI	INSTALLED LENGTH	#	1.0D PART #	1.5D PART #	2.0D PART #
1/8	28	1,5D 0,19"	10		3546-1/8X1.5DP	
1/4	19	1,5D 0,38"	10		3546-1/4X1.5DP	
1/4	19	2,0D 0,50"	10			3546-1/4X2.0DP
3/8	19	1,5D 0,56"	10		3546-3/8X1.5DP	
1/2	14	1,5D 0,75"	5		3546-1/2X1.5DP	
5/8	14	1,5D 0,94"	5		3546-5/8X1.5DP	
5/8	14	2,0D 1,25"	5			3546-5/8X2.0DP
3/4	14	1,0D 0,75"	5	3546-3/4X1.0DP		
3/4	14	1,5D 1,13"	5		3546-3/4X1.5DP	
7/8	14	1,5D 1,32"	3		3546-7/8X1.5DP	
1	11	1,5D 1,50"	3		3546-1X1.5DP	

NPT		INSERT		FREE RUNNING		
INCH	TPI	INSTALLED LENGTH	#	1.0D PART #	1.5D PART #	2.0D PART #
1/16	27	0,271"	10		3552-1/16X1.5DP	
1/8	27	0,273"	10		3552-1/8X1.5DP	
1/4	18	0,394"	10		3552-1/4X1.5DP	
3/8	18	0,407"	10		3552-3/8X1.5DP	
1/2	14	0,534"	5		3552-1/2X1.5DP	
3/4	14	0,553"	5		3552-3/4X1.5DP	
1	11	0,661"	3		3552-1X1.5DP	



<b>GROUP</b>	—
<b>INSERT TYPE</b>	WIRE THREAD
<b>INSERT MATERIAL</b>	304 STAINLESS STEEL
<b>STYLE</b>	<b>FREE RUNNING</b>

<b>MERCHANDISER</b>	<b>PART #</b>
POWERCOIL HANG SELL MERCHANDISER	<b>3500-D1</b>

<b>CONTENTS</b>			
#	MM / INCH	PART #	PART #
<b>METRIC COARSE</b>			
1	4 x 0.7	3520-4.00K	3520-4.00 x 1.5DP
1	5 x 0.8	3520-5.00K	3520-5.00 x 1.5DP
1	6 x 1.0	3520-6.00K	3520-6.00 x 1.5DP
1	6 x 1.0		3520-6.00 x 2.0DP
1	8 x 1.25	3520-8.00K	3520-8.00 x 1.5DP
1	8 x 1.25		3520-8.00 x 2.0DP
1	10 x 1.5	3520-10.00K	3520-10.00 x 1.5DP
1	12 x 1.75	3520-12.00K	3520-12.00 x 1.5DP
1	12 x 1.75		3520-12.00 x 2.0DP
1	16 x 2.0	3520-16.00K	3520-16.00 x 1.5DP
1	10 x 1.25	3521-10.00K	3521-10.00 x 1.5DP
1	12 x 1.5	3521-12.00K	3521-12.00 x 1.5DP
<b>SPARK PLUG</b>			
1	12 x 1.25	3522-12.00K	3522-12.00 x 1/2P
1	12 x 1.25		3522-12.00 x 3/4P
1	14 x 1.25	3522-14.00K	3522-14.00 x 3/8P
1	14 x 1.25		3522-14.00 x 1/2P
1	14 x 1.25		3522-14.00 x 3/4P
<b>UNC</b>			
1	1/4 x 20	3532-1/4K	3532-1/4 x 1.5DP
1	5/16 x 18	3532-5/16K	3532-5/16 x 1.5DP
1	3/8 x 16	3532-3/8K	3532-3/8 x 1.5DP
1	3/8 x 16		3532-3/8 x 2.0DP
1	7/16 x 14	3532-7/16K	3532-7/16 x 1.5DP
1	1/2 x 13	3532-1/2K	3532-1/2 x 1.5DP
1	5/8 x 11	3532-5/8K	3532-5/8 x 1.5DP
1	3/4 x 10	3532-3/4K	3532-3/4 x 1.5DP
<b>UNF</b>			
1	1/4 x 28	3534-1/4K	3534-1/4 x 1.5DP
1	5/16 x 24	3534-5/16K	3534-5/16 x 1.5DP
1	3/8 x 24	3534-3/8K	3534-3/8 x 1.5DP
1	7/16 x 20	3534-7/16K	3534-7/16 x 1.5DP
1	1/2 x 20	3534-1/2K	3534-1/2 x 1.5DP
<b>BSW</b>			
1	1/2 x 12	3528-1/2K	3528-1/2 x 1.5DP

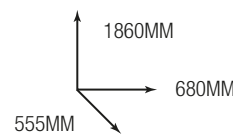

Picture is representative of merchandiser appearance.  
Actual contents as listed.



MC



GROUP	—
INSERT TYPE	WIRE THREAD
INSERT MATERIAL	304 STAINLESS STEEL
STYLE	FREE RUNNING

MERCHANDISER	PART #
POWERCOIL BENCH MERCHANDISER	3500-CS1

CONTENTS			
#	MM / INCH	PART #	PART #
<b>METRIC COARSE</b>			
1	5 x 0.8	3520-5.00K	3520-5.00 x 1.5DP
1	6 x 1.0	3520-6.00K	3520-6.00 x 1.0DP
1	6 x 1.0	—	3520-6.00 x 1.5DP
1	6 x 1.0	—	3520-6.00 x 2.0DP
1	8 x 1.25	3520-8.00K	3520-8.00 x 1.0DP
1	8 x 1.25	—	3520-8.00 x 1.5DP
1	8 x 1.25	—	3520-8.00 x 2.0DP
1	10 x 1.5	3520-10.00K	3520-10.00 x 1.5DP
1	10 x 1.5	—	3520-10.00 x 2.0DP
1	12 x 1.75	3520-12.00K	3520-12.00 x 1.5DP
1	16 x 2.0	3520-16.00K	3520-16.00 x 1.5DP
<b>SPARK PLUG</b>			
1	14 x 1.25	3522-14.00K	3522-14.00 x 3/8P
1	14 x 1.25	—	3522-14.00 x 1/2P
1	14 x 1.25	—	3522-14.00 x 3/4P

MERCHANDISER	PART #
POWERCOIL BENCH MERCHANDISER	3500-CS2

CONTENTS			
#	MM / INCH	PART #	PART #
<b>METRIC COARSE</b>			
1	6 x 1.0	3520-6.00K	3520-6.00 x 1.0DP
1	6 x 1.0	—	3520-6.00 x 1.5DP
1	6 x 1.0	—	3520-6.00 x 2.0DP
1	8 x 1.25	3520-8.00K	3520-8.00 x 1.0DP
1	8 x 1.25	—	3520-8.00 x 1.5DP
1	8 x 1.25	—	3520-8.00 x 2.0DP
1	10 x 1.5	3520-10.00K	3520-10.00 x 1.5DP
1	12 x 1.75	3520-12.00K	3520-12.00 x 1.5DP
<b>UNC</b>			
1	1/4 x 20	3532-1/4K	3532-1/4 x 1.5DP
1	5/16 x 18	3532-5/16K	3532-5/16 x 1.5DP
1	3/8 x 16	3532-3/8K	3532-3/8 x 1.5DP
1	3/8 x 16	—	3532-3/8 x 2.0DP
1	1/2 x 13	3532-1/2K	3532-1/2 x 1.5DP

PowerCoil bench merchandisers are double sided units that display thread repair kits on one side and replacement insert packets on the other.

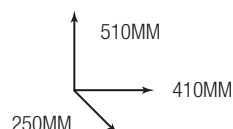



**MC  
UNC**



<b>GROUP</b>	—
<b>INSERT TYPE</b>	WIRE THREAD
<b>INSERT MATERIAL</b>	304 STAINLESS STEEL
<b>STYLE</b>	<b>FREE RUNNING</b>

<b>MERCHANDISER</b>	<b>PART #</b>
POWERCOIL DISPLAY BAY MERCHANDISER	<b>3500-FD1</b>

**CONTENTS**

#	MM / INCH	PART #	PART #
<b>METRIC COARSE</b>			
1	2.5 x 0.45	3520-2.50K	3520-2.50X1.5DP
1	3 x 0.5	3520-3.00K	3520-3.00X1.5DP
1	4 x 0.7	3520-4.00K	3520-4.00X1.5DP
1	5 x 0.8	3520-5.00K	3520-5.00X1.5DP
1	6 x 1.0	3520-6.00K	3520-6.00X1.0DP
1	6 x 1.0	—	3520-6.00X1.5DP
1	6 x 1.0	—	3520-6.00X2.0DP
1	7 x 1.0	3520-7.00K	3520-7.00X1.5DP
1	8 x 1.25	3520-8.00K	3520-8.00X1.0DP
1	8 x 1.25	—	3520-8.00X1.5DP
1	8 x 1.25	—	3520-8.00X2.0DP
1	9 x 1.25	3520-9.00K	—
1	10 x 1.5	3520-10.00K	3520-10.00X1.0DP
1	10 x 1.5	—	3520-10.00X1.5DP
1	10 x 1.5	—	3520-10.00X2.0DP
1	11 x 1.5	3520-11.00K	—
1	12 x 1.75	3520-12.00K	3520-12.00X1.0DP
1	12 x 1.75	—	3520-12.00X1.5DP
1	12 x 1.75	—	3520-12.00X2.0DP
1	14 x 2.0	3520-14.00K	3520-14.00X1.5DP
1	16 x 2.0	3520-16.00K	3520-16.00X1.5DP
1	18 x 2.5	3520-18.00K	3520-18.00X1.5DP
1	20 x 2.5	3520-20.00K	3520-20.00X1.5DP
1	24 x 3.0	3520-24.00K	3520-24.00X1.5DP
<b>METRIC FINE</b>			
1	8 x 1.0	3521-8.00K	3521-8.00X1.5DP
1	10 x 1.25	3521-10.00K	3521-10.00X1.5DP
1	10 x 1.0	3523-10.00K	3523-10.00X1.5DP
1	12 x 1.5	3521-12.00K	3521-12.00X1.5DP
1	12 x 1.25	3523-12.00K	3523-12.00X1.5DP
1	14 x 1.5	3521-14.00K	3521-14.00X1.5DP
1	16 x 1.5	3521-16.00K	3521-16.00X1.5DP
1	18 x 1.5	3523-18.00K	3523-18.00X1.5DP
1	20 x 1.5	3523-20.00K	3523-20.00X1.5DP
<b>SPARK PLUG</b>			
1	12 x 1.25	3522-12.00K	3522-12.00 x 1/2P
1	12 x 1.25	—	3522-12.00 x 3/4P
1	14 x 1.25	3522-14.00K	3522-14.00 x 3/8P
1	14 x 1.25	—	3522-14.00 x 1/2P
1	14 x 1.25	—	3522-14.00 x 3/4P
<b>UNC</b>			
1	4G x 40	3532-4GK	3532-4GX1.5DP
1	6G x 32	3532-6GK	3532-6GX1.5DP
1	8G x 32	3532-8GK	3532-8GX1.5DP
1	10G x 24	3532-10GK	3532-10GX1.5DP
1	12G x 24	3532-12GK	3532-12GX1.5DP
1	1/4 x 20	3532-1/4K	3532-1/4X1.5DP
1	5/16 x 18	3532-5/16K	3532-5/16X1.5DP
1	3/8 x 16	3532-3/8K	3532-3/8X1.5DP
1	7/16 x 14	3532-7/16K	3532-7/16X1.5DP
1	1/2 x 13	3532-1/2K	3532-1/2X1.5DP
1	9/16 x 12	3532-9/16K	3532-9/16X1.5DP
1	5/8 x 11	3532-5/8K	3532-5/8X1.5DP
1	3/4 x 10	3532-3/4K	3532-3/4X1.5DP
1	7/8 x 9	3532-7/8K	3532-7/8X1.5DP
1	1 x 8	3532-1K	3532-1X1.5DP
<b>UNF</b>			
1	10G x 32	3534-10GK	3534-10GX1.5DP
1	1/4 x 28	3534-1/4K	3534-1/4X1.5DP
1	5/16 x 24	3534-5/16K	3534-5/16X1.5DP
1	3/8 x 24	3534-3/8K	3534-3/8X1.5DP
1	7/16 x 20	3534-7/16K	3534-7/16X1.5DP
1	1/2 x 20	3534-1/2K	3534-1/2X1.5DP
1	9/16 x 18	3534-9/16K	3534-9/16X1.5DP
1	5/8 x 18	3534-5/8K	3534-5/8X1.5DP
1	3/4 x 16	3534-3/4K	3534-3/4X1.5DP
<b>BSW</b>			
1	1/2 x 12	3528-1/2K	3528-1/2 x 1.5DP
<b>BSP</b>			
1	1/8 x 28	3546-1/8K	3546-1/8X1.5DP
1	1/4 x 19	3546-1/4K	3546-1/4X1.5DP

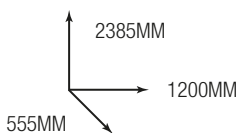

Picture is representative of merchandiser appearance.  
Actual contents as listed.



<b>GROUP</b>	<b>PCWI</b>
<b>INSERT TYPE</b>	WIRE THREAD
<b>INSERT MATERIAL</b>	304 STAINLESS STEEL

**METRIC COARSE – 1.0D BULK INSERTS**

INSERT			FREE RUNNING	FREE RUNNING MIL SPEC		SCREW LOCKING MIL SPEC	
MM	MM	MM	PART #	PART #	MIL SPEC	PART #	MIL SPEC
M2	0,40	2,00	3520-2.00X1.0D	3520-2.00X1.0D-MA	MA3279-140		
M2.2	0,45	2,20	3520-2.20X1.0D	3520-2.20X1.0D-MA	MA3279-100	3520-2.20X1.0DSL	MA3329-100
M2.5	0,45	2,50	3520-2.50X1.0D	3520-2.50X1.0D-MA	MA3279-101	3520-2.50X1.0DSL	MA3329-101
M3	0,50	3,00	3520-3.00X1.0D	3520-3.00X1.0D-MA	MA3279-102	3520-3.00X1.0DSL	MA3329-102
M3.5	0,60	3,50	3520-3.50X1.0D	3520-3.50X1.0D-MA	MA3279-103	3520-3.50X1.0DSL	MA3329-103
M4	0,70	4,00	3520-4.00X1.0D	3520-4.00X1.0D-MA	MA3279-104	3520-4.00X1.0DSL	MA3329-104
M5	0,80	5,00	3520-5.00X1.0D	3520-5.00X1.0D-MA	MA3279-105	3520-5.00X1.0DSL	MA3329-105
M6	1,00	6,00	3520-6.00X1.0D	3520-6.00X1.0D-MA	MA3279-106	3520-6.00X1.0DSL	MA3329-106
M7	1,00	7,00	3520-7.00X1.0D	3520-7.00X1.0D-MA	MA3279-107	3520-7.00X1.0DSL	MA3329-107
M8	1,25	8,00	3520-8.00X1.0D	3520-8.00X1.0D-MA	MA3279-109	3520-8.00X1.0DSL	MA3329-109
M9	1,25	9,00	3520-9.00X1.0D				
M10	1,50	10,00	3520-10.00X1.0D	3520-10.00X1.0D-MA	MA3279-111	3520-10.00X1.0DSL	MA3329-111
M11	1,50	11,00	3520-11.00X1.0D				
M12	1,75	12,00	3520-12.00X1.0D	3520-12.00X1.0D-MA	MA3279-114	3520-12.00X1.0DSL	MA3329-114
M13	1,75	13,00	3520-13.00X1.0D				
M14	2,00	14,00	3520-14.00X1.0D	3520-14.00X1.0D-MA	MA3279-116	3520-14.00X1.0DSL	MA3329-116
M15	2,00	15,00	3520-15.00X1.0D				
M16	2,00	16,00	3520-16.00X1.0D	3520-16.00X1.0D-MA	MA3279-118	3520-16.00X1.0DSL	MA3329-118
M18	2,50	18,00	3520-18.00X1.0D	3520-18.00X1.0D-MA	MA3279-121	3520-18.00X1.0DSL	MA3329-121
M20	2,50	20,00	3520-20.00X1.0D	3520-20.00X1.0D-MA	MA3279-124	3520-20.00X1.0DSL	MA3329-124
M22	2,50	22,00	3520-22.00X1.0D	3520-22.00X1.0D-MA	MA3279-127	3520-22.00X1.0DSL	MA3329-127
M24	3,00	24,00	3520-24.00X1.0D	3520-24.00X1.0D-MA	MA3279-129	3520-24.00X1.0DSL	MA3329-129

**METRIC COARSE – 1.5D BULK INSERTS**

INSERT			FREE RUNNING	FREE RUNNING MIL SPEC		SCREW LOCKING MIL SPEC	
MM	MM	MM	PART #	PART #	MIL SPEC	PART #	MIL SPEC
M2	0,40	3,00	3520-2.00X1.5D	3520-2.00X1.5D-MA	MA3279-190		
M2.2	0,45	3,30	3520-2.20X1.5D	3520-2.20X1.5D-MA	MA3279-150	3520-2.20X1.5DSL	MA3329-150
M2.5	0,45	3,75	3520-2.50X1.5D	3520-2.50X1.5D-MA	MA3279-151	3520-2.50X1.5DSL	MA3329-151
M3	0,50	4,50	3520-3.00X1.5D	3520-3.00X1.5D-MA	MA3279-152	3520-3.00X1.5DSL	MA3329-152
M3.5	0,60	5,25	3520-3.50X1.5D	3520-3.50X1.5D-MA	MA3279-153	3520-3.50X1.5DSL	MA3329-153
M4	0,70	6,00	3520-4.00X1.5D	3520-4.00X1.5D-MA	MA3279-154	3520-4.00X1.5DSL	MA3329-154
M5	0,80	7,50	3520-5.00X1.5D	3520-5.00X1.5D-MA	MA3279-155	3520-5.00X1.5DSL	MA3329-155
M6	1,00	9,00	3520-6.00X1.5D	3520-6.00X1.5D-MA	MA3279-156	3520-6.00X1.5DSL	MA3329-156
M7	1,00	10,50	3520-7.00X1.5D	3520-7.00X1.5D-MA	MA3279-157	3520-7.00X1.5DSL	MA3329-157
M8	1,25	12,00	3520-8.00X1.5D	3520-8.00X1.5D-MA	MA3279-159	3520-8.00X1.5DSL	MA3329-159
M9	1,25	13,50	3520-9.00X1.5D				
M10	1,50	15,00	3520-10.00X1.5D	3520-10.00X1.5D-MA	MA3279-161	3520-10.00X1.5DSL	MA3329-161
M11	1,50	16,50	3520-11.00X1.5D				
M12	1,75	18,00	3520-12.00X1.5D	3520-12.00X1.5D-MA	MA3279-164	3520-12.00X1.5DSL	MA3329-164
M13	1,75	19,50	3520-13.00X1.5D				
M14	2,00	21,00	3520-14.00X1.5D	3520-14.00X1.5D-MA	MA3279-166	3520-14.00X1.5DSL	MA3329-166
M15	2,00	22,50	3520-15.00X1.5D				
M16	2,00	24,00	3520-16.00X1.5D	3520-16.00X1.5D-MA	MA3279-168	3520-16.00X1.5DSL	MA3329-168
M18	2,50	27,00	3520-18.00X1.5D	3520-18.00X1.5D-MA	MA3279-171	3520-18.00X1.5DSL	MA3329-171
M20	2,50	30,00	3520-20.00X1.5D	3520-20.00X1.5D-MA	MA3279-174	3520-20.00X1.5DSL	MA3329-174
M22	2,50	33,00	3520-22.00X1.5D	3520-22.00X1.5D-MA	MA3279-177	3520-22.00X1.5DSL	MA3329-177
M24	3,00	36,00	3520-24.00X1.5D	3520-24.00X1.5D-MA	MA3279-179	3520-24.00X1.5DSL	MA3329-179
M27	3,00	40,50	3520-27.00X1.5D	3520-27.00X1.5D-MA	MA3279-181		
M30	3,50	45,00	3520-30.00X1.5D				
M33	3,50	49,50	3520-33.00X1.5D				
M36	4,00	54,00	3520-36.00X1.5D				

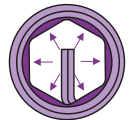

**MC**

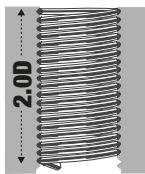

<b>GROUP</b>	<b>PCWI</b>
INSERT TYPE	WIRE THREAD
INSERT MATERIAL	304 STAINLESS STEEL

METRIC COARSE – 2.0D BULK INSERTS							
INSERT			FREE RUNNING	FREE RUNNING MIL SPEC		SCREW LOCKING MIL SPEC	
MM	MM	MM	PART #	PART #	MIL SPEC	PART #	MIL SPEC
M2	0,40	4,00	3520-2.00X2.0D	3520-2.00X2.0D-MA	MA3279-240		
M2.2	0,45	4,40	3520-2.20X2.0D	3520-2.20X2.0D-MA	MA3279-200	3520-2.20X2.0DSL	MA3329-200
M2.5	0,45	5,00	3520-2.50X2.0D	3520-2.50X2.0D-MA	MA3279-201	3520-2.50X2.0DSL	MA3329-201
M3	0,50	6,00	3520-3.00X2.0D	3520-3.00X2.0D-MA	MA3279-202	3520-3.00X2.0DSL	MA3329-202
M3.5	0,60	7,00	3520-3.50X2.0D	3520-3.50X2.0D-MA	MA3279-203	3520-3.50X2.0DSL	MA3329-203
M4	0,70	8,00	3520-4.00X2.0D	3520-4.00X2.0D-MA	MA3279-204	3520-4.00X2.0DSL	MA3329-204
M5	0,80	10,00	3520-5.00X2.0D	3520-5.00X2.0D-MA	MA3279-205	3520-5.00X2.0DSL	MA3329-205
M6	1,00	12,00	3520-6.00X2.0D	3520-6.00X2.0D-MA	MA3279-206	3520-6.00X2.0DSL	MA3329-206
M7	1,00	14,00	3520-7.00X2.0D	3520-7.00X2.0D-MA	MA3279-207	3520-7.00X2.0DSL	MA3329-207
M8	1,25	16,00	3520-8.00X2.0D	3520-8.00X2.0D-MA	MA3279-209	3520-8.00X2.0DSL	MA3329-209
M9	1,25	18,00	3520-9.00X2.0D				
M10	1,50	20,00	3520-10.00X2.0D	3520-10.00X2.0D-MA	MA3279-211	3520-10.00X2.0DSL	MA3329-211
M11	1,50	22,00	3520-11.00X2.0D				
M12	1,75	24,00	3520-12.00X2.0D	3520-12.00X2.0D-MA	MA3279-214	3520-12.00X2.0DSL	MA3329-214
M13	1,75	26,00	3520-13.00X2.0D				
M14	2,00	28,00	3520-14.00X2.0D	3520-14.00X2.0D-MA	MA3279-216	3520-14.00X2.0DSL	MA3329-216
M15	2,00	30,00	3520-15.00X2.0D				
M16	2,00	32,00	3520-16.00X2.0D	3520-16.00X2.0D-MA	MA3279-218	3520-16.00X2.0DSL	MA3329-218
M18	2,50	36,00	3520-18.00X2.0D	3520-18.00X2.0D-MA	MA3279-221	3520-18.00X2.0DSL	MA3329-221
M20	2,50	40,00	3520-20.00X2.0D	3520-20.00X2.0D-MA	MA3279-224	3520-20.00X2.0DSL	MA3329-224
M22	2,50	44,00	3520-22.00X2.0D	3520-22.00X2.0D-MA	MA3279-227	3520-22.00X2.0DSL	MA3329-227
M24	3,00	48,00	3520-24.00X2.0D	3520-24.00X2.0D-MA	MA3279-229	3520-24.00X2.0DSL	MA3329-229

METRIC COARSE – 2.5D BULK INSERTS							
INSERT			FREE RUNNING	FREE RUNNING MIL SPEC		SCREW LOCKING MIL SPEC	
MM	MM	MM	PART #	PART #	MIL SPEC	PART #	MIL SPEC
M2	0,40	5,00	3520-2.00X2.5D	3520-2.00X2.5D-MA	MA3279-290		
M2.2	0,45	5,50	3520-2.20X2.5D	3520-2.20X2.5D-MA	MA3279-250	3520-2.20X2.5DSL	MA3329-250
M2.5	0,45	6,25	3520-2.50X2.5D	3520-2.50X2.5D-MA	MA3279-251	3520-2.50X2.5DSL	MA3329-251
M3	0,50	7,50	3520-3.00X2.5D	3520-3.00X2.5D-MA	MA3279-252	3520-3.00X2.5DSL	MA3329-252
M3.5	0,60	8,75	3520-3.50X2.5D	3520-3.50X2.5D-MA	MA3279-253	3520-3.50X2.5DSL	MA3329-253
M4	0,70	10,00	3520-4.00X2.5D	3520-4.00X2.5D-MA	MA3279-254	3520-4.00X2.5DSL	MA3329-254
M5	0,80	12,50	3520-5.00X2.5D	3520-5.00X2.5D-MA	MA3279-255	3520-5.00X2.5DSL	MA3329-255
M6	1,00	15,00	3520-6.00X2.5D	3520-6.00X2.5D-MA	MA3279-256	3520-6.00X2.5DSL	MA3329-256
M7	1,00	17,50	3520-7.00X2.5D	3520-7.00X2.5D-MA	MA3279-257	3520-7.00X2.5DSL	MA3329-257
M8	1,25	20,00	3520-8.00X2.5D	3520-8.00X2.5D-MA	MA3279-259	3520-8.00X2.5DSL	MA3329-259
M9	1,25	22,50	3520-9.00X2.5D				
M10	1,50	25,00	3520-10.00X2.5D	3520-10.00X2.5D-MA	MA3279-261	3520-10.00X2.5DSL	MA3329-261
M11	1,50	27,50	3520-11.00X2.5D				
M12	1,75	30,00	3520-12.00X2.5D	3520-12.00X2.5D-MA	MA3279-264	3520-12.00X2.5DSL	MA3329-264
M14	2,00	35,00	3520-14.00X2.5D	3520-14.00X2.5D-MA	MA3279-266	3520-14.00X2.5DSL	MA3329-266
M16	2,00	40,00	3520-16.00X2.5D	3520-16.00X2.5D-MA	MA3279-268	3520-16.00X2.5DSL	MA3329-268
M18	2,50	45,00	3520-18.00X2.5D	3520-18.00X2.5D-MA	MA3279-271	3520-18.00X2.5DSL	MA3329-271
M20	2,50	50,00	3520-20.00X2.5D	3520-20.00X2.5D-MA	MA3279-274	3520-20.00X2.5DSL	MA3329-274
M22	2,50	55,00	3520-22.00X2.5D	3520-22.00X2.5D-MA	MA3279-277	3520-22.00X2.5DSL	MA3329-277
M24	3,00	60,00	3520-24.00X2.5D	3520-24.00X2.5D-MA	MA3279-279	3520-24.00X2.5DSL	MA3329-279

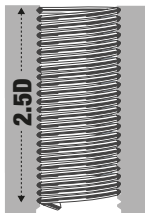



<b>GROUP</b>	<b>PCWI</b>
<b>INSERT TYPE</b>	WIRE THREAD
<b>INSERT MATERIAL</b>	304 STAINLESS STEEL

**METRIC COARSE – 3.0D BULK INSERTS**

INSERT		FREE RUNNING		FREE RUNNING MIL SPEC		SCREW LOCKING MIL SPEC	
MM	MM	MM	PART #	PART #	MIL SPEC	PART #	MIL SPEC
M2	0,40	6,00	<b>3520-2.00X3.0D</b>	3520-2.00X3.0D-MA	MA3279-340		
M2.2	0,45	6,60	<b>3520-2.20X3.0D</b>	3520-2.20X3.0D-MA	MA3279-300	3520-2.20X3.0DSL	MA3329-300
M2.5	0,45	7,50	<b>3520-2.50X3.0D</b>	3520-2.50X3.0D-MA	MA3279-301	3520-2.50X3.0DSL	MA3329-301
M3	0,50	9,00	<b>3520-3.00X3.0D</b>	3520-3.00X3.0D-MA	MA3279-302	3520-3.00X3.0DSL	MA3329-302
M3.5	0,60	10,50	<b>3520-3.50X3.0D</b>	3520-3.50X3.0D-MA	MA3279-303	3520-3.50X3.0DSL	MA3329-303
M4	0,70	12,00	<b>3520-4.00X3.0D</b>	3520-4.00X3.0D-MA	MA3279-304	3520-4.00X3.0DSL	MA3329-304
M5	0,80	15,00	<b>3520-5.00X3.0D</b>	3520-5.00X3.0D-MA	MA3279-305	3520-5.00X3.0DSL	MA3329-305
M6	1,00	18,00	<b>3520-6.00X3.0D</b>	3520-6.00X3.0D-MA	MA3279-306	3520-6.00X3.0DSL	MA3329-306
M7	1,00	21,00	<b>3520-7.00X3.0D</b>	3520-7.00X3.0D-MA	MA3279-307	3520-7.00X3.0DSL	MA3329-307
M8	1,25	24,00	<b>3520-8.00X3.0D</b>	3520-8.00X3.0D-MA	MA3279-309	3520-8.00X3.0DSL	MA3329-309
M9	1,25	27,00	<b>3520-9.00X3.0D</b>				
M10	1,50	30,00	<b>3520-10.00X3.0D</b>	3520-10.00X3.0D-MA	MA3279-311	3520-10.00X3.0DSL	MA3329-311
M11	1,50	33,00	<b>3520-11.00X3.0D</b>				
M12	1,75	36,00	<b>3520-12.00X3.0D</b>	3520-12.00X3.0D-MA	MA3279-314	3520-12.00X3.0DSL	MA3329-314
M14	2,00	42,00	<b>3520-14.00X3.0D</b>	3520-14.00X3.0D-MA	MA3279-316	3520-14.00X3.0DSL	MA3329-316
M16	2,00	48,00	<b>3520-16.00X3.0D</b>	3520-16.00X3.0D-MA	MA3279-318		
M18	2,50	54,00	<b>3520-18.00X3.0D</b>	3520-18.00X3.0D-MA	MA3279-321		
M20	2,50	60,00	<b>3520-20.00X3.0D</b>	3520-20.00X3.0D-MA	MA3279-324		
M22	2,50	66,00	<b>3520-22.00X3.0D</b>	3520-22.00X3.0D-MA	MA3279-327		
M24	3,00	72,00	<b>3520-24.00X3.0D</b>	3520-24.00X3.0D-MA	MA3279-329		



**Screw Locking Wire Thread Inserts**

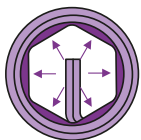

Screw locking (or prevailing torque) inserts are of particular value in applications subject to the effects of cyclic vibration or impact. In addition to the benefits afforded by free running inserts, PowerCoil screw locking inserts offer the additional security of prevailing locking torque. This is achieved by the action of one or more polygonal grip coils positioned within the insert's length, which exert radial pressure on the male thread. Each grip coil consists of a number of tangential locking chords which protrude inside the minor diameter of the normal free running coils. As the male thread passes through these grip coils, the locking flats are displaced thus exerting radial pressure or prevailing torque on the male thread. On removal of the male thread, the locking coils relax to their original form permitting repeated assembly whilst retaining a measurable level of prevailing torque.

Note: It is recommended that only close fit plated or lubricated bolts or screws are used with screw locking inserts.

**Call for the latest pricing and availability.**



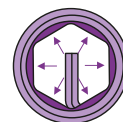
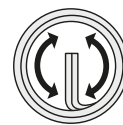

**MF**



<b>GROUP</b>	<b>PCWI</b>
INSERT TYPE	WIRE THREAD
INSERT MATERIAL	304 STAINLESS STEEL

METRIC FINE – 1.0D BULK INSERTS							
INSERT			FREE RUNNING	FREE RUNNING MIL SPEC		SCREW LOCKING MIL SPEC	
MM	MM	MM	PART #	PART #	MIL SPEC	PART #	MIL SPEC
M6	0,75	6,00	3521-6.00X1.0D				
M8	1,00	8,00	3521-8.00X1.0D	3521-8.00X1.0D-MA	MA3279-108	3521-8.00X1.0DSL	MA3329-108
M8	0,75	8,00	3523-8.00X1.0D				
M9	1,00	9,00	3521-9.00X1.0D				
M10	1,25	10,00	3521-10.00X1.0D	3521-10.00X1.0D-MA	MA3279-110	3521-10.00X1.0DSL	MA3329-110
M10	1,00	10,00	3523-10.00X1.0D	3523-10.00X1.0D-MA	MA3279-141		
M11	1,25	11,00	3521-11.00X1.0D				
M11	1,00	11,00	3523-11.00X1.0D				
M12	1,50	12,00	3521-12.00X1.0D	3521-12.00X1.0D-MA	MA3279-113	3521-12.00X1.0DSL	MA3329-113
M12	1,25	12,00	3523-12.00X1.0D	3523-12.00X1.0D-MA	MA3279-112	3523-12.00X1.0DSL	MA3329-112
M12	1,00	12,00	3524-12.00X1.0D				
M13	1,50	13,00	3521-13.00X1.0D				
M13	1,25	13,00	3523-13.00X1.0D				
M14	1,50	14,00	3521-14.00X1.0D	3521-14.00X1.0D-MA	MA3279-115	3521-14.00X1.0DSL	MA3329-115
M14	1,25	14,00	3523-14.00X1.0D				
M14	1,00	14,00	3524-14.00X1.0D				
M15	1,50	15,00	3521-15.00X1.0D				
M16	1,50	16,00	3521-16.00X1.0D	3521-16.00X1.0D-MA	MA3279-117	3521-16.00X1.0DSL	MA3329-117
M18	2,00	18,00	3521-18.00X1.0D	3521-18.00X1.0D-MA	MA3279-120	3521-18.00X1.0DSL	MA3329-120
M18	1,50	18,00	3523-18.00X1.0D	3523-18.00X1.0D-MA	MA3279-119	3523-18.00X1.0DSL	MA3329-119
M20	2,00	20,00	3521-20.00X1.0D	3521-20.00X1.0D-MA	MA3279-123	3521-20.00X1.0DSL	MA3329-123
M20	1,50	20,00	3523-20.00X1.0D	3523-20.00X1.0D-MA	MA3279-122	3523-20.00X1.0DSL	MA3329-122
M22	2,00	22,00	3521-22.00X1.0D	3521-22.00X1.0D-MA	MA3279-126	3521-22.00X1.0DSL	MA3329-126
M22	1,50	22,00	3523-22.00X1.0D	3523-22.00X1.0D-MA	MA3279-125	3523-22.00X1.0DSL	MA3329-125
M24	2,00	24,00	3521-24.00X1.0D	3521-24.00X1.0D-MA	MA3279-128	3521-24.00X1.0DSL	MA3329-128
M24	1,50	24,00	3523-24.00X1.0D				



**Strip Feed**  
Free Running Inserts  
Page 43



<b>GROUP</b>	<b>PCWI</b>
<b>INSERT TYPE</b>	WIRE THREAD
<b>INSERT MATERIAL</b>	304 STAINLESS STEEL

**METRIC FINE – 1.5D BULK INSERTS**

INSERT			FREE RUNNING	FREE RUNNING MIL SPEC		SCREW LOCKING MIL SPEC	
MM	MM	MM	PART #	PART #	MIL SPEC	PART #	MIL SPEC
M6	0,75	9,00	3521-6.00X1.5D				
M8	1,00	12,00	3521-8.00X1.5D	3521-8.00X1.5D-MA	MA3279-158	3521-8.00X1.5DSL	MA3329-158
M8	0,75	12,00	3523-8.00X1.5D				
M9	1,00	13,50	3521-9.00X1.5D				
M10	1,25	15,00	3521-10.00X1.5D	3521-10.00X1.5D-MA	MA3279-160	3521-10.00X1.5DSL	MA3329-160
M10	1,00	15,00	3523-10.00X1.5D	3523-10.00X1.5D-MA	MA3279-191		
M11	1,25	16,50	3521-11.00X1.5D				
M11	1,00	16,50	3523-11.00X1.5D				
M12	1,50	18,00	3521-12.00X1.5D	3521-12.00X1.5D-MA	MA3279-163	3521-12.00X1.5DSL	MA3329-163
M12	1,25	18,00	3523-12.00X1.5D	3523-12.00X1.5D-MA	MA3279-162	3523-12.00X1.5DSL	MA3329-162
M12	1,00	18,00	3524-12.00X1.5D				
M13	1,50	19,50	3521-13.00X1.5D				
M13	1,25	19,50	3523-13.00X1.5D				
M14	1,50	21,00	3521-14.00X1.5D	3521-14.00X1.5D-MA	MA3279-165	3521-14.00X1.5DSL	MA3329-165
M14	1,25	21,00	3523-14.00X1.5D				
M14	1,00	21,00	3524-14.00X1.5D				
M15	1,50	22,50	3521-15.00X1.5D				
M16	1,50	24,00	3521-16.00X1.5D	3521-16.00X1.5D-MA	MA3279-167	3521-16.00X1.5DSL	MA3329-167
M18	2,00	27,00	3521-18.00X1.5D	3521-18.00X1.5D-MA	MA3279-170	3521-18.00X1.5DSL	MA3329-170
M18	1,50	27,00	3523-18.00X1.5D	3523-18.00X1.5D-MA	MA3279-169	3523-18.00X1.5DSL	MA3329-169
M20	2,00	30,00	3521-20.00X1.5D	3521-20.00X1.5D-MA	MA3279-173	3521-20.00X1.5DSL	MA3329-173
M20	1,50	30,00	3523-20.00X1.5D	3523-20.00X1.5D-MA	MA3279-172	3523-20.00X1.5DSL	MA3329-172
M22	2,00	33,00	3521-22.00X1.5D	3521-22.00X1.5D-MA	MA3279-176	3521-22.00X1.5DSL	MA3329-176
M22	1,50	33,00	3523-22.00X1.5D	3523-22.00X1.5D-MA	MA3279-175	3523-22.00X1.5DSL	MA3329-175
M24	2,00	36,00	3521-24.00X1.5D	3521-24.00X1.5D-MA	MA3279-178	3521-24.00X1.5DSL	MA3329-178
M24	1,50	36,00	3523-24.00X1.5D				
M26	1,50	39,00	3523-26.00X1.5D				
M27	2,00	40,50	3521-27.00X1.5D	3521-27.00X1.5D-MA	MA3279-180		
M27	1,50	40,50	3523-27.00X1.5D				
M28	1,50	42,00	3523-28.00X1.5D				
M30	2,00	45,00	3521-30.00X1.5D	3521-30.00X1.5D-MA	MA3279-182		
M30	1,50	45,00	3523-30.00X1.5D				
M33	2,00	49,50	3521-33.00X1.5D	3521-33.00X1.5D-MA	MA3279-184		
M36	3,00	54,00	3521-36.00X1.5D	3521-36.00X1.5D-MA	MA3279-187		
M36	2,00	54,00	3523-36.00X1.5D				
M36	1,50	54,00	3524-36.00X1.5D				

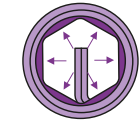

**MF**

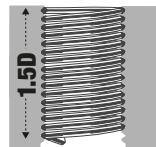

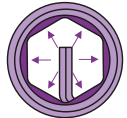

**MF**

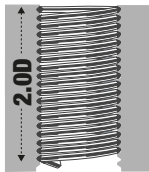

<b>GROUP</b>	<b>PCWI</b>
INSERT TYPE	WIRE THREAD
INSERT MATERIAL	304 STAINLESS STEEL

**METRIC FINE – 2.0D BULK INSERTS**

INSERT			FREE RUNNING	FREE RUNNING MIL SPEC		SCREW LOCKING MIL SPEC	
MM	MM	MM	PART #	PART #	MIL SPEC	PART #	MIL SPEC
M6	0,75	12,00	3521-6.00X2.0D				
M8	1,00	16,00	3521-8.00X2.0D	3521-8.00X2.0D-MA	MA3279-208	3521-8.00X2.0DSL	MA3329-208
M8	0,75	16,00	3523-8.00X2.0D				
M9	1,00	18,00	3521-9.00X2.0D				
M10	1,25	20,00	3521-10.00X2.0D	3521-10.00X2.0D-MA	MA3279-210	3521-10.00X2.0DSL	MA3329-210
M10	1,00	20,00	3523-10.00X2.0D	3523-10.00X2.0D-MA	MA3279-241		
M11	1,25	22,00	3521-11.00X2.0D				
M11	1,00	22,00	3523-11.00X2.0D				
M12	1,50	24,00	3521-12.00X2.0D	3521-12.00X2.0D-MA	MA3279-213	3521-12.00X2.0DSL	MA3329-213
M12	1,25	24,00	3523-12.00X2.0D	3523-12.00X2.0D-MA	MA3279-212	3523-12.00X2.0DSL	MA3329-212
M12	1,00	24,00	3524-12.00X2.0D				
M13	1,50	26,00	3521-13.00X2.0D				
M13	1,25	26,00	3523-13.00X2.0D				
M14	1,50	28,00	3521-14.00X2.0D	3521-14.00X2.0D-MA	MA3279-215	3521-14.00X2.0DSL	MA3329-215
M14	1,25	28,00	3523-14.00X2.0D				
M14	1,00	28,00	3524-14.00X2.0D				
M15	1,50	30,00	3521-15.00X2.0D				
M16	1,50	32,00	3521-16.00X2.0D	3521-16.00X2.0D-MA	MA3279-217	3521-16.00X2.0DSL	MA3329-217
M18	2,00	36,00	3521-18.00X2.0D	3521-18.00X2.0D-MA	MA3279-220	3521-18.00X2.0DSL	MA3329-220
M18	1,50	36,00	3523-18.00X2.0D	3523-18.00X2.0D-MA	MA3279-219	3523-18.00X2.0DSL	MA3329-219
M20	2,00	40,00	3523-20.00X2.0D	3523-20.00X2.0D-MA	MA3279-222	3523-20.00X2.0DSL	MA3329-222
M20	1,50	40,00	3521-20.00X2.0D	3521-20.00X2.0D-MA	MA3279-223	3521-20.00X2.0DSL	MA3329-223
M22	2,00	44,00	3521-22.00X2.0D	3521-22.00X2.0D-MA	MA3279-226	3521-22.00X2.0DSL	MA3329-226
M22	1,50	44,00	3523-22.00X2.0D	3523-22.00X2.0D-MA	MA3279-225	3523-22.00X2.0DSL	MA3329-225
M24	2,00	48,00	3521-24.00X2.0D	3521-24.00X2.0D-MA	MA3279-228	3521-24.00X2.0DSL	MA3329-228
M24	1,50	48,00	3523-24.00X2.0D				

**METRIC FINE – 2.5D BULK INSERTS**

INSERT			FREE RUNNING	FREE RUNNING MIL SPEC		SCREW LOCKING MIL SPEC	
MM	MM	MM	PART #	PART #	MIL SPEC	PART #	MIL SPEC
M6	0,75	15,00	3521-6.00X2.5D				
M8	1,00	20,00	3521-8.00X2.5D	3521-8.00X2.5D-MA	MA3279-258	3521-8.00X2.5DSL	MA3329-258
M8	0,75	20,00	3523-8.00X2.5D				
M9	1,00	22,50	3521-9.00X2.5D				
M10	1,25	25,00	3521-10.00X2.5D	3521-10.00X2.5D-MA	MA3279-260	3521-10.00X2.5DSL	MA3329-260
M10	1,00	25,00	3523-10.00X2.5D	3523-10.00X2.5D-MA	MA3279-291		
M11	1,25	27,50	3521-11.00X2.5D				
M11	1,00	27,50	3523-11.00X2.5D				
M12	1,50	30,00	3521-12.00X2.5D	3521-12.00X2.5D-MA	MA3279-263	3521-12.00X2.5DSL	MA3329-263
M12	1,25	30,00	3523-12.00X2.5D	3523-12.00X2.5D-MA	MA3279-262	3523-12.00X2.5DSL	MA3329-262
M12	1,00	30,00	3524-12.00X2.5D				
M14	1,50	35,00	3521-14.00X2.5D	3521-14.00X2.5D-MA	MA3279-265	3521-14.00X2.5DSL	MA3329-265
M14	1,25	35,00	3523-14.00X2.5D				
M14	1,00	35,00	3524-14.00X2.5D				
M16	1,50	40,00	3521-16.00X2.5D	3521-16.00X2.5D-MA	MA3279-267	3521-16.00X2.5DSL	MA3329-267
M18	2,00	45,00	3521-18.00X2.5D	3521-18.00X2.5D-MA	MA3279-270	3521-18.00X2.5DSL	MA3329-270
M18	1,50	45,00	3523-18.00X2.5D	3523-18.00X2.5D-MA	MA3279-269	3523-18.00X2.5DSL	MA3329-269
M20	2,00	50,00	3521-20.00X2.5D	3521-20.00X2.5D-MA	MA3279-273	3521-20.00X2.5DSL	MA3329-273
M20	1,50	50,00	3523-20.00X2.5D	3523-20.00X2.5D-MA	MA3279-272	3523-20.00X2.5DSL	MA3329-272
M22	2,00	55,00	3521-22.00X2.5D	3521-22.00X2.5D-MA	MA3279-276	3521-22.00X2.5DSL	MA3329-276
M22	1,50	55,00	3523-22.00X2.5D	3523-22.00X2.5D-MA	MA3279-275	3523-22.00X2.5DSL	MA3329-275
M24	2,00	60,00	3521-24.00X2.5D	3521-24.00X2.5D-MA	MA3279-278	3521-24.00X2.5DSL	MA3329-278
M24	1,50	60,00	3523-24.00X2.5D				

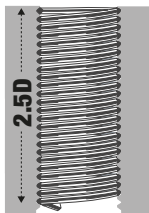



<b>GROUP</b>	<b>PCWI</b>
<b>INSERT TYPE</b>	WIRE THREAD
<b>INSERT MATERIAL</b>	304 STAINLESS STEEL

**METRIC FINE – 3.0D BULK INSERTS**

INSERT			FREE RUNNING	FREE RUNNING MIL SPEC		SCREW LOCKING MIL SPEC	
MM	MM	MM	PART #	PART #	MIL SPEC	PART #	MIL SPEC
M6	0,75	18,00	3521-6.00X3.0D				
M8	1,00	24,00	3521-8.00X3.0D	3521-8.00X3.0D-MA	MA3279-308	3521-8.00X3.0DSL	MA3329-308
M8	0,75	24,00	3523-8.00X3.0D				
M9	1,00	27,00	3521-9.00X3.0D				
M10	1,25	30,00	3521-10.00X3.0D	3521-10.00X3.0D-MA	MA3279-310	3521-10.00X3.0DSL	MA3329-310
M10	1,00	30,00	3523-10.00X3.0D	3523-10.00X3.0D-MA	MA3279-341		
M11	1,25	33,00	3521-11.00X3.0D				
M11	1,00	33,00	3523-11.00X3.0D				
M12	1,50	36,00	3521-12.00X3.0D	3521-12.00X3.0D-MA	MA3279-313	3521-12.00X3.0DSL	MA3329-313
M12	1,25	36,00	3523-12.00X3.0D	3523-12.00X3.0D-MA	MA3279-312	3523-12.00X3.0DSL	MA3329-312
M12	1,00	36,00	3524-12.00X3.0D				
M14	1,50	42,00	3521-14.00X3.0D	3521-14.00X3.0D-MA	MA3279-315	3521-14.00X3.0DSL	MA3329-315
M14	1,25	42,00	3523-14.00X3.0D				
M14	1,00	42,00	3524-14.00X3.0D				
M16	1,50	48,00	3521-16.00X3.0D	3521-16.00X3.0D-MA	MA3279-317	3521-16.00X3.0DSL	MA3329-317
M18	2,00	54,00	3521-18.00X3.0D	3521-18.00X3.0D-MA	MA3279-320		
M18	1,50	54,00	3523-18.00X3.0D	3523-18.00X3.0D-MA	MA3279-319	3523-18.00X3.0DSL	MA3329-319
M20	2,00	60,00	3521-20.00X3.0D	3521-20.00X3.0D-MA	MA3279-323		
M20	1,50	60,00	3523-20.00X3.0D	3523-20.00X3.0D-MA	MA3279-322		
M22	2,00	66,00	3521-22.00X3.0D	3521-22.00X3.0D-MA	MA3279-326		
M22	1,50	66,00	3523-22.00X3.0D	3523-22.00X3.0D-MA	MA3279-325		
M24	2,00	72,00	3521-24.00X3.0D	3521-24.00X3.0D-MA	MA3279-328		
M24	1,50	72,00	3523-24.00X3.0D				

**SPARK PLUG – BULK INSERTS**

INSERT			FREE RUNNING	FREE RUNNING MIL SPEC		SCREW LOCKING MIL SPEC	
MM	MM	LENGTH	PART #	PART #	MIL SPEC	PART #	MIL SPEC
<b>IMPERIAL LENGTH</b>							
M10	1,00	0,339"	3522-10.00X.339				
M10	1,00	1/2"	3522-10.00X1/2				
M12	1,25	1/2"	3522-12.00X1/2				
M12	1,25	3/4"	3522-12.00X3/4				
M14	1,25	3/8"	3522-14.00X3/8				
M14	1,25	7/16"	3522-14.00X7/16				
M14	1,25	1/2"	3522-14.00X1/2				
M14	1,25	3/4"	3522-14.00X3/4				
M18	1,50	1/2"	3522-18.00X1/2				
<b>METRIC LENGTH</b>							
M14	1,25	8,4MM	3522-14.00X8.4				
M14	1,25	12,4MM	3522-14.00X12.4				
M14	1,25	16,4MM	3522-14.00X16.4				



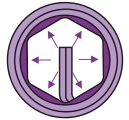

**UNC**



GROUP	PCWI
INSERT TYPE	WIRE THREAD
INSERT MATERIAL	304 STAINLESS STEEL

UNC – 1.0D BULK INSERTS								
INSERT			FREE RUNNING MIL SPEC			SCREW LOCKING MIL SPEC		
INCH	TPI	INCH	PART #	MIL SPEC	AEROSPACE	PART #	MIL SPEC	AEROSPACE
2G	56	0,09	3532-2GX1.0D	MS122095	NASM122095	3532-2GX1.0DSL	MS21209-C0210	NASM21209-C0210
3G	48	0,10	3532-3GX1.0D	MS122115	NASM122115			
4G	40	0,11	3532-4GX1.0D	MS122076	NASM122076	3532-4GX1.0DSL	MS21209-C0410	NASM21209-C0410
5G	40	0,13	3532-5GX1.0D	MS122077	NASM122077	3532-5GX1.0DSL	MS21209-C0510	NASM21209-C0510
6G	32	0,14	3532-6GX1.0D	MS122078	NASM122078	3532-6GX1.0DSL	MS21209-C0610	NASM21209-C0610
8G	32	0,16	3532-8GX1.0D	MS122079	NASM122079	3532-8GX1.0DSL	MS21209-C0810	NASM21209-C0810
10G	24	0,19	3532-10GX1.0D	MS122080	NASM122080	3532-10GX1.0DSL	MS21209-C1-10	NASM21209-C1-10
12G	24	0,22	3532-12GX1.0D			3532-12GX1.0DSL	MS21209-C2-10	NASM21209-C2-10
1/4	20	0,25	3532-1/4X1.0D	MS122081	NASM122081	3532-1/4X1.0DSL	MS21209-C4-10	NASM21209-C4-10
5/16	18	0,31	3532-5/16X1.0D	MS122082	NASM122082	3532-5/16X1.0DSL	MS21209-C5-10	NASM21209-C5-10
3/8	16	0,38	3532-3/8X1.0D	MS122083	NASM122083	3532-3/8X1.0DSL	MS21209-C6-10	NASM21209-C6-10
7/16	14	0,44	3532-7/16X1.0D	MS122084	NASM122084	3532-7/16X1.0DSL	MS21209-C7-10	NASM21209-C7-10
1/2	13	0,50	3532-1/2X1.0D	MS122085	NASM122085	3532-1/2X1.0DSL	MS21209-C8-10	NASM21209-C8-10
9/16	12	0,56	3532-9/16X1.0D	MS122086	NASM122086	3532-9/16X1.0DSL	MS21209-C9-10	NASM21209-C9-10
5/8	11	0,63	3532-5/8X1.0D	MS122087	NASM122087	3532-5/8X1.0DSL	MS21209-C1010	NASM21209-C1010
3/4	10	0,75	3532-3/4X1.0D	MS122088	NASM122088	3532-3/4X1.0DSL	MS21209-C1210	NASM21209-C1210
7/8	9	0,88	3532-7/8X1.0D	MS122089	NASM122089	3532-7/8X1.0DSL	MS21209-C1410	NASM21209-C1410
1	8	1,00	3532-1X1.0D	MS122090	NASM122090	3532-1X1.0DSL	MS21209-C1610	NASM21209-C1610

UNC – 1.5D BULK INSERTS								
INSERT			FREE RUNNING MIL SPEC			SCREW LOCKING MIL SPEC		
INCH	TPI	INCH	PART #	MIL SPEC	AEROSPACE	PART #	MIL SPEC	AEROSPACE
2G	56	0,14	3532-2GX1.5D	MS122135	NASM122135	3532-2GX1.5DSL	MS21209-C0215	NASM21209-C0215
3G	48	0,15	3532-3GX1.5D	MS122155	NASM122155			
4G	40	0,17	3532-4GX1.5D	MS122116	NASM122116	3532-4GX1.5DSL	MS21209-C0415	NASM21209-C0415
5G	40	0,20	3532-5GX1.5D	MS122117	NASM122117	3532-5GX1.5DSL	MS21209-C0515	NASM21209-C0515
6G	32	0,21	3532-6GX1.5D	MS122118	NASM122118	3532-6GX1.5DSL	MS21209-C0615	NASM21209-C0615
8G	32	0,24	3532-8GX1.5D	MS122119	NASM122119	3532-8GX1.5DSL	MS21209-C0815	NASM21209-C0815
10G	24	0,29	3532-10GX1.5D	MS122120	NASM122120	3532-10GX1.5DSL	MS21209-C1-15	NASM21209-C1-15
12G	24	0,33	3532-12GX1.5D			3532-12GX1.5DSL	MS21209-C2-15	NASM21209-C2-15
1/4	20	0,38	3532-1/4X1.5D	MS122121	NASM122121	3532-1/4X1.5DSL	MS21209-C4-15	NASM21209-C4-15
5/16	18	0,47	3532-5/16X1.5D	MS122122	NASM122122	3532-5/16X1.5DSL	MS21209-C5-15	NASM21209-C5-15
3/8	16	0,57	3532-3/8X1.5D	MS122123	NASM122123	3532-3/8X1.5DSL	MS21209-C6-15	NASM21209-C6-15
7/16	14	0,66	3532-7/16X1.5D	MS122124	NASM122124	3532-7/16X1.5DSL	MS21209-C7-15	NASM21209-C7-15
1/2	13	0,75	3532-1/2X1.5D	MS122125	NASM122125	3532-1/2X1.5DSL	MS21209-C8-15	NASM21209-C8-15
9/16	12	0,84	3532-9/16X1.5D	MS122126	NASM122126	3532-9/16X1.5DSL	MS21209-C9-15	NASM21209-C9-15
5/8	11	0,95	3532-5/8X1.5D	MS122127	NASM122127	3532-5/8X1.5DSL	MS21209-C1015	NASM21209-C1015
3/4	10	1,13	3532-3/4X1.5D	MS122128	NASM122128	3532-3/4X1.5DSL	MS21209-C1215	NASM21209-C1215
7/8	9	1,32	3532-7/8X1.5D	MS122129	NASM122129	3532-7/8X1.5DSL	MS21209-C1415	NASM21209-C1415
1	8	1,50	3532-1X1.5D	MS122130	NASM122130	3532-1X1.5DSL	MS21209-C1615	NASM21209-C1615
1-1/8	7	1,70	3532-1.1/8X1.5D	MS122131	NASM122131	3532-1.1/8X1.5DSL	MS21209-C1815	NASM21209-C1815
1-1/4	7	1,88	3532-1.1/4X1.5D	MS122132	NASM122132	3532-1.1/4X1.5DSL	MS21209-C2015	NASM21209-C2015
1-3/8	6	2,07	3532-1.3/8X1.5D	MS122133	NASM122133	3532-1.3/8X1.5DSL	MS21209-C2215	NASM21209-C2215
1-1/2	6	2,25	3532-1.1/2X1.5D	MS122134	NASM122134	3532-1.1/2X1.5DSL	MS21209-C2415	NASM21209-C2415

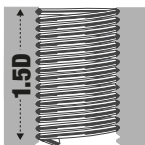



<b>GROUP</b>	<b>PCWI</b>
INSERT TYPE	WIRE THREAD
INSERT MATERIAL	304 STAINLESS STEEL

**UNC – 2.0D BULK INSERTS**

INSERT			FREE RUNNING MIL SPEC			SCREW LOCKING MIL SPEC		
INCH	TPI	INCH	PART #	MS	NASM	PART #	MS	NASM
				AEROSPACE	AEROSPACE		AEROSPACE	
<b>2G</b>	56	0,18	<b>3532-2GX2.0D</b>	MS122175	NASM122175	3532-2GX2.0DSL	MS21209-C0220	NASM21209-C0220
<b>3G</b>	48	0,20	<b>3532-3GX2.0D</b>	MS122195	NASM122195			
<b>4G</b>	40	0,22	<b>3532-4GX2.0D</b>	MS122156	NASM122156	3532-4GX2.0DSL	MS21209-C0420	NASM21209-C0420
<b>5G</b>	40	0,26	<b>3532-5GX2.0D</b>	MS122157	NASM122157	3532-5GX2.0DSL	MS21209-C0520	NASM21209-C0520
<b>6G</b>	32	0,28	<b>3532-6GX2.0D</b>	MS122158	NASM122158	3532-6GX2.0DSL	MS21209-C0620	NASM21209-C0620
<b>8G</b>	32	0,32	<b>3532-8GX2.0D</b>	MS122159	NASM122159	3532-8GX2.0DSL	MS21209-C0820	NASM21209-C0820
<b>10G</b>	24	0,38	<b>3532-10GX2.0D</b>	MS122160	NASM122160	3532-10GX2.0DSL	MS21209-C1-20	NASM21209-C1-20
<b>12G</b>	24	0,44	<b>3532-12GX2.0D</b>			3532-12GX2.0DSL	MS21209-C2-20	NASM21209-C2-20
<b>1/4</b>	20	0,50	<b>3532-1/4X2.0D</b>	MS122161	NASM122161	3532-1/4X2.0DSL	MS21209-C4-20	NASM21209-C4-20
<b>5/16</b>	18	0,62	<b>3532-5/16X2.0D</b>	MS122162	NASM122162	3532-5/16X2.0DSL	MS21209-C5-20	NASM21209-C5-20
<b>3/8</b>	16	0,76	<b>3532-3/8X2.0D</b>	MS122163	NASM122163	3532-3/8X2.0DSL	MS21209-C6-20	NASM21209-C6-20
<b>7/16</b>	14	0,88	<b>3532-7/16X2.0D</b>	MS122164	NASM122164	3532-7/16X2.0DSL	MS21209-C7-20	NASM21209-C7-20
<b>1/2</b>	13	1,00	<b>3532-1/2X2.0D</b>	MS122165	NASM122165	3532-1/2X2.0DSL	MS21209-C8-20	NASM21209-C8-20
<b>9/16</b>	12	1,12	<b>3532-9/16X2.0D</b>	MS122166	NASM122166	3532-9/16X2.0DSL	MS21209-C9-20	NASM21209-C9-20
<b>5/8</b>	11	1,26	<b>3532-5/8X2.0D</b>	MS122167	NASM122167	3532-5/8X2.0DSL	MS21209-C1020	NASM21209-C1020
<b>3/4</b>	10	1,50	<b>3532-3/4X2.0D</b>	MS122168	NASM122168	3532-3/4X2.0DSL	MS21209-C1220	NASM21209-C1220
<b>7/8</b>	9	1,76	<b>3532-7/8X2.0D</b>	MS122169	NASM122169	3532-7/8X2.0DSL	MS21209-C1420	NASM21209-C1420
<b>1</b>	8	2,00	<b>3532-1X2.0D</b>	MS122170	NASM122170	3532-1X2.0DSL	MS21209-C1620	NASM21209-C1620

**UNC – 2.5D BULK INSERTS**

INSERT			FREE RUNNING MIL SPEC			SCREW LOCKING MIL SPEC		
INCH	TPI	INCH	PART #	MS	NASM	PART #	MS	NASM
				AEROSPACE	AEROSPACE		AEROSPACE	
<b>2G</b>	56	0,23	<b>3532-2GX2.5D</b>	MS122215	NASM122215	3532-2GX2.5DSL	MS21209-C0225	NASM21209-C0225
<b>4G</b>	48	0,25	<b>3532-4GX2.5D</b>	MS122196	NASM122196	3532-4GX2.5DSL	MS21209-C0425	NASM21209-C0425
<b>5G</b>	40	0,28	<b>3532-5GX2.5D</b>	MS122197	NASM122197	3532-5GX2.5DSL	MS21209-C0525	NASM21209-C0525
<b>6G</b>	40	0,33	<b>3532-6GX2.5D</b>	MS122198	NASM122198	3532-6GX2.5DSL	MS21209-C0625	NASM21209-C0625
<b>8G</b>	32	0,35	<b>3532-8GX2.5D</b>	MS122199	NASM122199	3532-8GX2.5DSL	MS21209-C0825	NASM21209-C0825
<b>10G</b>	32	0,40	<b>3532-10GX2.5D</b>	MS122200	NASM122200	3532-10GX2.5DSL	MS21209-C1-25	NASM21209-C1-25
<b>12G</b>	24	0,48	<b>3532-12GX2.5D</b>			3532-12GX2.5DSL	MS21209-C2-25	NASM21209-C2-25
<b>1/4</b>	24	0,55	<b>3532-1/4X2.5D</b>	MS122201	NASM122201	3532-1/4X2.5DSL	MS21209-C4-25	NASM21209-C4-25
<b>5/16</b>	20	0,63	<b>3532-5/16X2.5D</b>	MS122202	NASM122202	3532-5/16X2.5DSL	MS21209-C5-25	NASM21209-C5-25
<b>3/8</b>	18	0,78	<b>3532-3/8X2.5D</b>	MS122203	NASM122203	3532-3/8X2.5DSL	MS21209-C6-25	NASM21209-C6-25
<b>7/16</b>	16	0,95	<b>3532-7/16X2.5D</b>	MS122204	NASM122204	3532-7/16X2.5DSL	MS21209-C7-25	NASM21209-C7-25
<b>1/2</b>	14	1,10	<b>3532-1/2X2.5D</b>	MS122205	NASM122205	3532-1/2X2.5DSL	MS21209-C8-25	NASM21209-C8-25
<b>9/16</b>	13	1,25	<b>3532-9/16X2.5D</b>	MS122206	NASM122206	3532-9/16X2.5DSL	MS21209-C9-25	NASM21209-C9-25
<b>5/8</b>	12	1,40	<b>3532-5/8X2.5D</b>	MS122207	NASM122207	3532-5/8X2.5DSL	MS21209-C1025	NASM21209-C1025
<b>3/4</b>	11	1,58	<b>3532-3/4X2.5D</b>	MS122208	NASM122208	3532-3/4X2.5DSL	MS21209-C1225	NASM21209-C1225
<b>7/8</b>	10	1,88	<b>3532-7/8X2.5D</b>	MS122209	NASM122209	3532-7/8X2.5DSL	MS21209-C1425	NASM21209-C1425
<b>1</b>	8	2,50	<b>3532-1X2.5D</b>	MS122210	NASM122210	3532-1X2.5DSL	MS21209-C1625	NASM21209-C1625

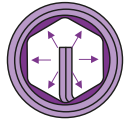

**UNC**

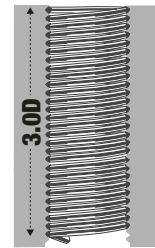

<b>GROUP</b>	<b>PCWI</b>
INSERT TYPE	WIRE THREAD
INSERT MATERIAL	304 STAINLESS STEEL

UNC – 3.0D BULK INSERTS								
INSERT			FREE RUNNING MIL SPEC			SCREW LOCKING MIL SPEC		
INCH	TPI	INCH	3.0D	MS	NASM	3.0D	MS	NASM
				AEROSPACE	AEROSPACE		AEROSPACE	AEROSPACE
			PART #	MIL SPEC	AEROSPACE	PART #	MIL SPEC	AEROSPACE
2G	56	0,27	<b>3532-2GX3.0D</b>	MS122255	NASM122255	3532-2GX3.0DSL	MS21209-C0230	NASM21209-C0230
4G	40	0,33	<b>3532-4GX3.0D</b>	MS122236	NASM122236	3532-4GX3.0DSL	MS21209-C0430	NASM21209-C0430
5G	40	0,39	<b>3532-5GX3.0D</b>	MS122237	NASM122237	3532-5GX3.0DSL	MS21209-C0530	NASM21209-C0530
6G	32	0,42	<b>3532-6GX3.0D</b>	MS122238	NASM122238	3532-6GX3.0DSL	MS21209-C0630	NASM21209-C0630
8G	32	0,48	<b>3532-8GX3.0D</b>	MS122239	NASM122239	3532-8GX3.0DSL	MS21209-C0830	NASM21209-C0830
10G	24	0,57	<b>3532-10GX3.0D</b>	MS122240	NASM122240	3532-10GX3.0DSL	MS21209-C1-30	NASM21209-C1-30
12G	24	0,66	<b>3532-12GX3.0D</b>			3532-12GX3.0DSL	MS21209-C2-30	NASM21209-C2-30
1/4	20	0,75	<b>3532-1/4X3.0D</b>	MS122241	NASM122241	3532-1/4X3.0DSL	MS21209-C4-30	NASM21209-C4-30
5/16	18	0,93	<b>3532-5/16X3.0D</b>	MS122242	NASM122242	3532-5/16X3.0DSL	MS21209-C5-30	NASM21209-C5-30
3/8	16	1,14	<b>3532-3/8X3.0D</b>	MS122243	NASM122243	3532-3/8X3.0DSL	MS21209-C6-30	NASM21209-C6-30
7/16	14	1,32	<b>3532-7/16X3.0D</b>	MS122244	NASM122244	3532-7/16X3.0DSL	MS21209-C7-30	NASM21209-C7-30
1/2	13	1,50	<b>3532-1/2X3.0D</b>	MS122245	NASM122245	3532-1/2X3.0DSL	MS21209-C8-30	NASM21209-C8-30
9/16	12	1,68	<b>3532-9/16X3.0D</b>	MS122246	NASM122246	3532-9/16X3.0DSL	MS21209-C9-30	NASM21209-C9-30
5/8	11	1,89	<b>3532-5/8X3.0D</b>	MS122247	NASM122247	3532-5/8X3.0DSL	MS21209-C1030	NASM21209-C1030
3/4	10	2,25	<b>3532-3/4X3.0D</b>	MS122248	NASM122248	3532-3/4X3.0DSL	MS21209-C1230	NASM21209-C1230
7/8	9	2,64	<b>3532-7/8X3.0D</b>	MS122249	NASM122249	3532-7/8X3.0DSL	MS21209-C1430	NASM21209-C1430
1	8	3,00	<b>3532-1X3.0D</b>	MS122250	NASM122250	3532-1X3.0DSL	MS21209-C1630	NASM21209-C1630



UNF

1.0D, 1.5D



<b>GROUP</b>	<b>PCWI</b>
<b>INSERT TYPE</b>	WIRE THREAD
<b>INSERT MATERIAL</b>	304 STAINLESS STEEL

**UNF – 1.0D BULK INSERTS**

INSERT			FREE RUNNING	FREE RUNNING MIL SPEC			SCREW LOCKING MIL SPEC		
INCH	TPI	INCH	PART #	PART #	MS	NASM	PART #	MS	NASM
					MIL SPEC	AEROSPACE		MIL SPEC	AEROSPACE
3G	56	0,10	<b>3534-3GX1.0D</b>	3534-3GX1.0D-MS	MS124670	NASM124670			
4G	48	0,11	<b>3534-4GX1.0D</b>	3534-4GX1.0D-MS	MS124671	NASM124671	3534-4GX1.0DSL	MS21209-F0410	NASM21209-F0410
6G	40	0,14	<b>3534-6GX1.0D</b>	3534-6GX1.0D-MS	MS124653	NASM124653	3534-6GX1.0DSL	MS21209-F0610	NASM21209-F0610
8G	36	0,16	<b>3534-8GX1.0D</b>	3534-8GX1.0D-MS	MS124654	NASM124654	3534-8GX1.0DSL	MS21209-F0810	NASM21209-F0810
10G	32	0,19	<b>3534-10GX1.0D</b>	3534-10GX1.0D-MS	MS124655	NASM124655	3534-10GX1.0DSL	MS21209-F1-10	NASM21209-F1-10
12G	28	0,22	<b>3534-12GX1.0D</b>						
1/4	28	0,25	<b>3534-1/4X1.0D</b>	3534-1/4X1.0D-MS	MS124656	NASM124656	3534-1/4X1.0DSL	MS21209-F4-10	NASM21209-F4-10
5/16	24	0,31	<b>3534-5/16X1.0D</b>	3534-5/16X1.0D-MS	MS124657	NASM124657	3534-5/16X1.0DSL	MS21209-F5-10	NASM21209-F5-10
3/8	24	0,38	<b>3534-3/8X1.0D</b>	3534-3/8X1.0D-MS	MS124658	NASM124658	3534-3/8X1.0DSL	MS21209-F6-10	NASM21209-F6-10
7/16	16	0,44	<b>3534-7/16-16X1.0D</b>						
7/16	20	0,44	<b>3534-7/16X1.0D</b>	3534-7/16X1.0D-MS	MS124659	NASM124659	3534-7/16X1.0DSL	MS21209-F7-10	NASM21209-F7-10
1/2	20	0,50	<b>3534-1/2X1.0D</b>	3534-1/2X1.0D-MS	MS124660	NASM124660	3534-1/2X1.0DSL	MS21209-F8-10	NASM21209-F8-10
9/16	18	0,56	<b>3534-9/16X1.0D</b>	3534-9/16X1.0D-MS	MS124661	NASM124661	3534-9/16X1.0DSL	MS21209-F9-10	NASM21209-F9-10
5/8	18	0,63	<b>3534-5/8X1.0D</b>	3534-5/8X1.0D-MS	MS124662	NASM124662	3534-5/8X1.0DSL	MS21209-F1010	NASM21209-F1010
3/4	16	0,75	<b>3534-3/4X1.0D</b>	3534-3/4X1.0D-MS	MS124663	NASM124663	3534-3/4X1.0DSL	MS21209-F1210	NASM21209-F1210
7/8	14	0,88	<b>3534-7/8X1.0D</b>	3534-7/8X1.0D-MS	MS124664	NASM124664	3534-7/8X1.0DSL	MS21209-F1410	NASM21209-F1410
1	12	1,00	<b>3534-1X1.0D</b>	3534-1X1.0D-MS	MS124665	NASM124665	3534-1X1.0DSL	MS21209-F1610	NASM21209-F1610

**UNF – 1.5D BULK INSERTS**

INSERT			FREE RUNNING	FREE RUNNING MIL SPEC			SCREW LOCKING MIL SPEC		
INCH	TPI	INCH	PART #	PART #	MS	NASM	PART #	MS	NASM
					MIL SPEC	AEROSPACE		MIL SPEC	AEROSPACE
3G	56	0,15	<b>3534-3GX1.5D</b>	3534-3GX1.5D-MS	MS124710	NASM124710			
4G	48	0,17	<b>3534-4GX1.5D</b>	3534-4GX1.5D-MS	MS124711	NASM124711	3534-4GX1.5DSL	MS21209-F0415	NASM21209-F0415
6G	40	0,21	<b>3534-6GX1.5D</b>	3534-6GX1.5D-MS	MS124693	NASM124693	3534-6GX1.5DSL	MS21209-F0615	NASM21209-F0615
8G	36	0,24	<b>3534-8GX1.5D</b>	3534-8GX1.5D-MS	MS124694	NASM124694	3534-8GX1.5DSL	MS21209-F0815	NASM21209-F0815
10G	32	0,29	<b>3534-10GX1.5D</b>	3534-10GX1.5D-MS	MS124695	NASM124695	3534-10GX1.5DSL	MS21209-F1-15	NASM21209-F1-15
12G	28	0,32	<b>3534-12GX1.5D</b>						
1/4	28	0,38	<b>3534-1/4X1.5D</b>	3534-1/4X1.5D-MS	MS124696	NASM124696	3534-1/4X1.5DSL	MS21209-F4-15	NASM21209-F4-15
5/16	24	0,47	<b>3534-5/16X1.5D</b>	3534-5/16X1.5D-MS	MS124697	NASM124697	3534-5/16X1.5DSL	MS21209-F5-15	NASM21209-F5-15
3/8	24	0,57	<b>3534-3/8X1.5D</b>	3534-3/8X1.5D-MS	MS124698	NASM124698	3534-3/8X1.5DSL	MS21209-F6-15	NASM21209-F6-15
7/16	20	0,66	<b>3534-7/16X1.5D</b>	3534-7/16X1.5D-MS	MS124699	NASM124699	3534-7/16X1.5DSL	MS21209-F7-15	NASM21209-F7-15
1/2	20	0,75	<b>3534-1/2X1.5D</b>	3534-1/2X1.5D-MS	MS124700	NASM124700	3534-1/2X1.5DSL	MS21209-F8-15	NASM21209-F8-15
9/16	18	0,84	<b>3534-9/16X1.5D</b>	3534-9/16X1.5D-MS	MS124701	NASM124701	3534-9/16X1.5DSL	MS21209-F9-15	NASM21209-F9-15
5/8	18	0,95	<b>3534-5/8X1.5D</b>	3534-5/8X1.5D-MS	MS124702	NASM124702	3534-5/8X1.5DSL	MS21209-F1015	NASM21209-F1015
3/4	16	1,13	<b>3534-3/4X1.5D</b>	3534-3/4X1.5D-MS	MS124703	NASM124703	3534-3/4X1.5DSL	MS21209-F1215	NASM21209-F1215
7/8	14	1,32	<b>3534-7/8X1.5D</b>	3534-7/8X1.5D-MS	MS124704	NASM124704	3534-7/8X1.5DSL	MS21209-F1415	NASM21209-F1415
1	12	1,50	<b>3534-1X1.5D</b>	3534-1X1.5D-MS	MS124705	NASM124705	3534-1X1.5DSL	MS21209-F1615	NASM21209-F1615
1	14	1,50	<b>3535-1X1.5D</b>	3535-1X1.5D-MS	MS124691	NASM124691			
1-1/8	12	1,70	<b>3534-1.1/8X1.5D</b>	3534-1.1/8X1.5D-MS	MS124706	NASM124706	3534-1.1/8X1.5DSL	MS21209-F1815	NASM21209-F1815
1-1/4	12	1,88	<b>3534-1.1/4X1.5D</b>	3534-1.1/4X1.5D-MS	MS124707	NASM124707	3534-1.1/4X1.5DSL	MS21209-F2015	NASM21209-F2015
1-3/8	12	2,07	<b>3534-1.3/8X1.5D</b>	3534-1.3/8X1.5D-MS	MS124708	NASM124708	3534-1.3/8X1.5DSL	MS21209-F2215	NASM21209-F2215
1-1/2	12	2,25	<b>3534-1.1/2X1.5D</b>	3534-1.1/2X1.5D-MS	MS124709	NASM124709	3534-1.1/2X1.5DSL	MS21209-F2415	NASM21209-F2415





<b>GROUP</b>	<b>PCWI</b>
INSERT TYPE	WIRE THREAD
INSERT MATERIAL	304 STAINLESS STEEL

**UNF – 2.0D BULK INSERTS**

INSERT			FREE RUNNING	FREE RUNNING MIL SPEC			SCREW LOCKING MIL SPEC		
INCH	TPI	INCH	PART #	PART #	MIL SPEC	AEROSPACE	PART #	MIL SPEC	AEROSPACE
<b>3G</b>	56	0,20	<b>3534-3GX2.0D</b>	3534-3GX2.0D-MS	MS124750	NASM124750			
<b>4G</b>	48	0,22	<b>3534-4GX2.0D</b>	3534-4GX2.0D-MS	MS124751	NASM124751	3534-4GX2.0DSL	MS21209-F0420	NASM21209-F0420
<b>6G</b>	40	0,28	<b>3534-6GX2.0D</b>	3534-6GX2.0D-MS	MS124733	NASM124733	3534-6GX2.0DSL	MS21209-F0620	NASM21209-F0620
<b>8G</b>	36	0,32	<b>3534-8GX2.0D</b>	3534-8GX2.0D-MS	MS124734	NASM124734	3534-8GX2.0DSL	MS21209-F0820	NASM21209-F0820
<b>10G</b>	32	0,38	<b>3534-10GX2.0D</b>	3534-10GX2.0D-MS	MS124735	NASM124735	3534-10GX2.0DSL	MS21209-F1-20	NASM21209-F1-20
<b>12G</b>	28	0,43	<b>3534-12GX2.0D</b>						
<b>1/4</b>	28	0,50	<b>3534-1/4X2.0D</b>	3534-1/4X2.0D-MS	MS124736	NASM124736	3534-1/4X2.0DSL	MS21209-F4-20	NASM21209-F4-20
<b>5/16</b>	24	0,62	<b>3534-5/16X2.0D</b>	3534-5/16X2.0D-MS	MS124737	NASM124737	3534-5/16X2.0DSL	MS21209-F5-20	NASM21209-F5-20
<b>3/8</b>	24	0,76	<b>3534-3/8X2.0D</b>	3534-3/8X2.0D-MS	MS124738	NASM124738	3534-3/8X2.0DSL	MS21209-F6-20	NASM21209-F6-20
<b>7/16</b>	20	0,88	<b>3534-7/16X2.0D</b>	3534-7/16X2.0D-MS	MS124739	NASM124739	3534-7/16X2.0DSL	MS21209-F7-20	NASM21209-F7-20
<b>1/2</b>	20	1,00	<b>3534-1/2X2.0D</b>	3534-1/2X2.0D-MS	MS124740	NASM124740	3534-1/2X2.0DSL	MS21209-F8-20	NASM21209-F8-20
<b>9/16</b>	18	1,12	<b>3534-9/16X2.0D</b>	3534-9/16X2.0D-MS	MS124741	NASM124741	3534-9/16X2.0DSL	MS21209-F9-20	NASM21209-F9-20
<b>5/8</b>	18	1,26	<b>3534-5/8X2.0D</b>	3534-5/8X2.0D-MS	MS124742	NASM124742	3534-5/8X2.0DSL	MS21209-F1020	NASM21209-F1020
<b>3/4</b>	16	1,50	<b>3534-3/4X2.0D</b>	3534-3/4X2.0D-MS	MS124743	NASM124743	3534-3/4X2.0DSL	MS21209-F1220	NASM21209-F1220
<b>7/8</b>	14	1,76	<b>3534-7/8X2.0D</b>	3534-7/8X2.0D-MS	MS124744	NASM124744	3534-7/8X2.0DSL	MS21209-F1420	NASM21209-F1420
<b>1</b>	12	2,00	<b>3534-1X2.0D</b>	3534-1X2.0D-MS	MS124745	NASM124745	3534-1X2.0DSL	MS21209-F1620	NASM21209-F1620

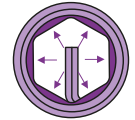
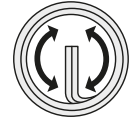

**UNF**

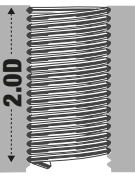

**UNF – 2.5D BULK INSERTS**

INSERT			FREE RUNNING	FREE RUNNING MIL SPEC			SCREW LOCKING MIL SPEC		
INCH	TPI	INCH	PART #	PART #	MIL SPEC	AEROSPACE	PART #	MIL SPEC	AEROSPACE
<b>4G</b>	48	0,28	<b>3534-4GX2.5D</b>	3534-4GX2.5D-MS	MS124791	NASM124791	3534-4GX2.5DSL	MS21209-F0425	NASM21209-F0425
<b>6G</b>	40	0,35	<b>3534-6GX2.5D</b>	3534-6GX2.5D-MS	MS124773	NASM124773	3534-6GX2.5DSL	MS21209-F0625	NASM21209-F0625
<b>8G</b>	36	0,40	<b>3534-8GX2.5D</b>	3534-8GX2.5D-MS	MS124774	NASM124774	3534-8GX2.5DSL	MS21209-F0825	NASM21209-F0825
<b>10G</b>	32	0,48	<b>3534-10GX2.5D</b>	3534-10GX2.5D-MS	MS124775	NASM124775	3534-10GX2.5DSL	MS21209-F1-25	NASM21209-F1-25
<b>12G</b>	28	0,54	<b>3534-12GX2.5D</b>						
<b>1/4</b>	28	0,63	<b>3534-1/4X2.5D</b>	3534-1/4X2.5D-MS	MS124776	NASM124776	3534-1/4X2.5DSL	MS21209-F4-25	NASM21209-F4-25
<b>5/16</b>	24	0,78	<b>3534-5/16X2.5D</b>	3534-5/16X2.5D-MS	MS124777	NASM124777	3534-5/16X2.5DSL	MS21209-F5-25	NASM21209-F5-25
<b>3/8</b>	24	0,95	<b>3534-3/8X2.5D</b>	3534-3/8X2.5D-MS	MS124778	NASM124778	3534-3/8X2.5DSL	MS21209-F6-25	NASM21209-F6-25
<b>7/16</b>	20	1,10	<b>3534-7/16X2.5D</b>	3534-7/16X2.5D-MS	MS124779	NASM124779	3534-7/16X2.5DSL	MS21209-F7-25	NASM21209-F7-25
<b>1/2</b>	20	1,25	<b>3534-1/2X2.5D</b>	3534-1/2X2.5D-MS	MS124780	NASM124780	3534-1/2X2.5DSL	MS21209-F8-25	NASM21209-F8-25
<b>9/16</b>	18	1,40	<b>3534-9/16X2.5D</b>	3534-9/16X2.5D-MS	MS124781	NASM124781	3534-9/16X2.5DSL	MS21209-F9-25	NASM21209-F9-25
<b>5/8</b>	18	1,58	<b>3534-5/8X2.5D</b>	3534-5/8X2.5D-MS	MS124782	NASM124782	3534-5/8X2.5DSL	MS21209-F1025	NASM21209-F1025
<b>3/4</b>	16	1,88	<b>3534-3/4X2.5D</b>	3534-3/4X2.5D-MS	MS124783	NASM124783	3534-3/4X2.5DSL	MS21209-F1225	NASM21209-F1225
<b>7/8</b>	14	2,20	<b>3534-7/8X2.5D</b>	3534-7/8X2.5D-MS	MS124784	NASM124784	3534-7/8X2.5DSL	MS21209-F1425	NASM21209-F1425
<b>1</b>	12	2,50	<b>3534-1X2.5D</b>	3534-1X2.5D-MS	MS124785	NASM124785	3534-1X2.5DSL	MS21209-F1625	NASM21209-F1625





UNF  
3.0D



<b>GROUP</b>	<b>PCWI</b>
<b>INSERT TYPE</b>	WIRE THREAD
<b>INSERT MATERIAL</b>	304 STAINLESS STEEL

**UNF – 3.0D BULK INSERTS**

INSERT		FREE RUNNING		FREE RUNNING MIL SPEC			SCREW LOCKING MIL SPEC		
INCH	TPI	INCH	PART #	PART #	MIL SPEC	AEROSPACE	PART #	MIL SPEC	AEROSPACE
4G	48	0,33	<b>3534-4GX3.0D</b>	3534-4GX3.0D-MS	MS124831	NASM124831	3534-4GX3.0DSL	MS21209-F0430	NASM21209-F0430
6G	40	0,42	<b>3534-6GX3.0D</b>	3534-6GX3.0D-MS	MS124813	NASM124813	3534-6GX3.0DSL	MS21209-F0630	NASM21209-F0630
8G	36	0,48	<b>3534-8GX3.0D</b>	3534-8GX3.0D-MS	MS124814	NASM124814	3534-8GX3.0DSL	MS21209-F0830	NASM21209-F0830
10G	32	0,57	<b>3534-10GX3.0D</b>	3534-10GX3.0D-MS	MS124815	NASM124815	3534-10GX3.0DSL	MS21209-F1-30	NASM21209-F1-30
12G	28	0,65	<b>3534-12GX3.0D</b>						
1/4	28	0,75	<b>3534-1/4X3.0D</b>	3534-1/4X3.0D-MS	MS124816	NASM124816	3534-1/4X3.0DSL	MS21209-F4-30	NASM21209-F4-30
5/16	24	0,93	<b>3534-5/16X3.0D</b>	3534-5/16X3.0D-MS	MS124817	NASM124817	3534-5/16X3.0DSL	MS21209-F5-30	NASM21209-F5-30
3/8	24	1,14	<b>3534-3/8X3.0D</b>	3534-3/8X3.0D-MS	MS124818	NASM124818	3534-3/8X3.0DSL	MS21209-F6-30	NASM21209-F6-30
7/16	20	1,32	<b>3534-7/16X3.0D</b>	3534-7/16X3.0D-MS	MS124819	NASM124819	3534-7/16X3.0DSL	MS21209-F7-30	NASM21209-F7-30
1/2	20	1,50	<b>3534-1/2X3.0D</b>	3534-1/2X3.0D-MS	MS124820	NASM124820	3534-1/2X3.0DSL	MS21209-F8-30	NASM21209-F8-30
9/16	18	1,68	<b>3534-9/16X3.0D</b>	3534-9/16X3.0D-MS	MS124821	NASM124821	3534-9/16X3.0DSL	MS21209-F9-30	NASM21209-F9-30
5/8	18	1,89	<b>3534-5/8X3.0D</b>	3534-5/8X3.0D-MS	MS124822	NASM124822	3534-5/8X3.0DSL	MS21209-F1030	NASM21209-F1030
3/4	16	2,25	<b>3534-3/4X3.0D</b>	3534-3/4X3.0D-MS	MS124823	NASM124823	3534-3/4X3.0DSL	MS21209-F1230	NASM21209-F1230
7/8	14	2,64	<b>3534-7/8X3.0D</b>	3534-7/8X3.0D-MS	MS124824	NASM124824	3534-7/8X3.0DSL	MS21209-F1430	NASM21209-F1430
1	12	3,00	<b>3534-1X3.0D</b>	3534-1X3.0D-MS	MS124825	NASM124825	3534-1X3.0DSL	MS21209-F1630	NASM21209-F1630





GROUP	PCWI
INSERT TYPE	WIRE THREAD
INSERT MATERIAL	304 STAINLESS STEEL
STYLE	<b>FREE RUNNING</b>

BSW – 1.0D BULK INSERTS			
INSERT			FREE RUNNING
INCH	TPI	INCH	PART #
1/8	40	0,13	3528-1/8X1.0D
3/16	24	0,19	3528-3/16X1.0D
1/4	20	0,25	3528-1/4X1.0D
5/16	18	0,31	3528-5/16X1.0D
3/8	16	0,38	3528-3/8X1.0D
7/16	14	0,44	3528-7/16X1.0D
1/2	12	0,50	3528-1/2X1.0D
9/16	12	0,56	3528-9/16X1.0D
5/8	11	0,63	3528-5/8X1.0D
3/4	10	0,75	3528-3/4X1.0D
7/8	9	0,88	3528-7/8X1.0D
1	8	1,00	3528-1X1.0D

BSW – 1.5D BULK INSERTS			
INSERT			FREE RUNNING
INCH	TPI	INCH	PART #
1/8	40	0,20	3528-1/8X1.5D
3/16	24	0,29	3528-3/16X1.5D
1/4	20	0,38	3528-1/4X1.5D
5/16	18	0,47	3528-5/16X1.5D
3/8	16	0,57	3528-3/8X1.5D
7/16	14	0,66	3528-7/16X1.5D
1/2	12	0,75	3528-1/2X1.5D
9/16	12	0,84	3528-9/16X1.5D
5/8	11	0,95	3528-5/8X1.5D
3/4	10	1,13	3528-3/4X1.5D
7/8	9	1,32	3528-7/8X1.5D
1	8	1,50	3528-1X1.5D



**BSW**

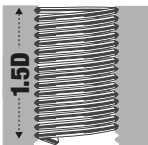

BSW – 2.0D BULK INSERTS			
INSERT			FREE RUNNING
INCH	TPI	INCH	PART #
1/8	40	0,26	3528-1/8X2.0D
3/16	24	0,38	3528-3/16X2.0D
1/4	20	0,50	3528-1/4X2.0D
5/16	18	0,62	3528-5/16X2.0D
3/8	16	0,76	3528-3/8X2.0D
7/16	14	0,88	3528-7/16X2.0D
1/2	12	1,00	3528-1/2X2.0D
9/16	12	1,12	3528-9/16X2.0D
5/8	11	1,26	3528-5/8X2.0D
3/4	10	1,50	3528-3/4X2.0D
7/8	9	1,76	3528-7/8X2.0D
1	8	2,00	3528-1X2.0D

BSW – 2.5D BULK INSERTS			
INSERT			FREE RUNNING
INCH	TPI	INCH	PART #
1/8	40	0,33	3528-1/8X2.5D
3/16	24	0,48	3528-3/16X2.5D
1/4	20	0,63	3528-1/4X2.5D
5/16	18	0,78	3528-5/16X2.5D
3/8	16	0,95	3528-3/8X2.5D
7/16	14	1,10	3528-7/16X2.5D
1/2	12	1,25	3528-1/2X2.5D
9/16	12	1,40	3528-9/16X2.5D
5/8	11	1,58	3528-5/8X2.5D
3/4	10	1,88	3528-3/4X2.5D
7/8	9	2,20	3528-7/8X2.5D
1	8	2,50	3528-1X2.5D

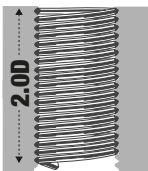

BSW – 3.0D BULK INSERTS			
INSERT			FREE RUNNING
INCH	TPI	INCH	PART #
1/8	40	0,39	3528-1/8X3.0D
3/16	24	0,57	3528-3/16X3.0D
1/4	20	0,75	3528-1/4X3.0D
5/16	18	0,93	3528-5/16X3.0D
3/8	16	1,14	3528-3/8X3.0D
7/16	14	1,32	3528-7/16X3.0D
1/2	12	1,50	3528-1/2X3.0D
9/16	12	1,68	3528-9/16X3.0D
5/8	11	1,89	3528-5/8X3.0D
3/4	10	2,25	3528-3/4X3.0D
7/8	9	2,64	3528-7/8X3.0D
1	8	3,00	3528-1X3.0D

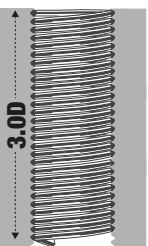



<b>GROUP</b>	<b>PCWI</b>
<b>INSERT TYPE</b>	WIRE THREAD
<b>INSERT MATERIAL</b>	304 STAINLESS STEEL
<b>STYLE</b>	<b>FREE RUNNING</b>

**BSF – 1.0D BULK INSERTS**

INSERT			FREE RUNNING
			 <b>1.0D</b>
INCH	TPI	INCH	PART #
3/16	32	0,19	3530-3/16X1.0D
1/4	26	0,25	3530-1/4X1.0D
5/16	22	0,31	3530-5/16X1.0D
3/8	20	0,38	3530-3/8X1.0D
7/16	18	0,44	3530-7/16X1.0D
1/2	16	0,50	3530-1/2X1.0D
9/16	16	0,56	3530-9/16X1.0D
5/8	14	0,63	3530-5/8X1.0D
3/4	12	0,75	3530-3/4X1.0D
7/8	11	0,88	3530-7/8X1.0D
1	10	1,00	3530-1X1.0D

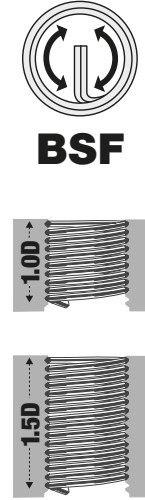

**BSF – 1.5D BULK INSERTS**

INSERT			FREE RUNNING
			 <b>1.5D</b>
INCH	TPI	INCH	PART #
3/16	32	0,29	3530-3/16X1.5D
1/4	26	0,38	3530-1/4X1.5D
5/16	22	0,47	3530-5/16X1.5D
3/8	20	0,57	3530-3/8X1.5D
7/16	18	0,66	3530-7/16X1.5D
1/2	16	0,75	3530-1/2X1.5D
9/16	16	0,84	3530-9/16X1.5D
5/8	14	0,95	3530-5/8X1.5D
3/4	12	1,13	3530-3/4X1.5D
7/8	11	1,32	3530-7/8X1.5D
1	10	1,50	3530-1X1.5D

**BSF – 2.0D BULK INSERTS**

INSERT			FREE RUNNING
			 <b>2.0D</b>
INCH	TPI	INCH	PART #
3/16	32	0,38	3530-3/16X2.0D
1/4	26	0,50	3530-1/4X2.0D
5/16	22	0,62	3530-5/16X2.0D
3/8	20	0,76	3530-3/8X2.0D
7/16	18	0,88	3530-7/16X2.0D
1/2	16	1,00	3530-1/2X2.0D
9/16	16	1,12	3530-9/16X2.0D
5/8	14	1,26	3530-5/8X2.0D
3/4	12	1,50	3530-3/4X2.0D
7/8	11	1,76	3530-7/8X2.0D
1	10	2,00	3530-1X2.0D

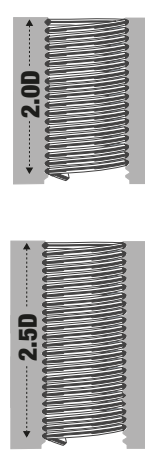

**BSF – 2.5D BULK INSERTS**

INSERT			FREE RUNNING
			 <b>2.5D</b>
INCH	TPI	INCH	PART #
3/16	32	0,48	3530-3/16X2.5D
1/4	26	0,63	3530-1/4X2.5D
5/16	22	0,78	3530-5/16X2.5D
3/8	20	0,95	3530-3/8X2.5D
7/16	18	1,10	3530-7/16X2.5D
1/2	16	1,25	3530-1/2X2.5D
9/16	16	1,40	3530-9/16X2.5D
5/8	14	1,58	3530-5/8X2.5D
3/4	12	1,88	3530-3/4X2.5D
7/8	11	2,20	3530-7/8X2.5D
1	10	2,50	3530-1X2.5D

**BSF – 3.0D BULK INSERTS**

INSERT			FREE RUNNING
			 <b>3.0D</b>
INCH	TPI	INCH	PART #
3/16	32	0,57	3530-3/16X3.0D
1/4	26	0,75	3530-1/4X3.0D
5/16	22	0,93	3530-5/16X3.0D
3/8	20	1,14	3530-3/8X3.0D
7/16	18	1,32	3530-7/16X3.0D
1/2	16	1,50	3530-1/2X3.0D
9/16	16	1,68	3530-9/16X3.0D
5/8	14	1,89	3530-5/8X3.0D
3/4	12	2,25	3530-3/4X3.0D
7/8	11	2,64	3530-7/8X3.0D
1	10	3,00	3530-1X3.0D

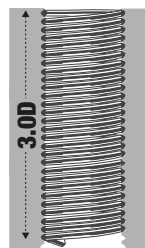

<b>GROUP</b>	<b>PCWI</b>
INSERT TYPE	WIRE THREAD
INSERT MATERIAL	304 STAINLESS STEEL
STYLE	<b>FREE RUNNING</b>



<b>BSP – 1.0D BULK INSERTS</b>			
INSERT			FREE RUNNING
			<b>1.0D</b>
INCH	TPI	INCH	PART #
1/8	28	0,13	3546-1/8X1.0D
1/4	19	0,25	3546-1/4X1.0D
3/8	19	0,38	3546-3/8X1.0D
1/2	14	0,50	3546-1/2X1.0D
5/8	14	0,63	3546-5/8X1.0D
3/4	14	0,75	3546-3/4X1.0D
7/8	14	0,88	3546-7/8X1.0D
1	11	1,00	3546-1X1.0D

<b>BSP – 1.5D BULK INSERTS</b>			
INSERT			FREE RUNNING
			<b>1.5D</b>
INCH	TPI	INCH	PART #
1/8	28	0,20	3546-1/8X1.5D
1/4	19	0,38	3546-1/4X1.5D
3/8	19	0,57	3546-3/8X1.5D
1/2	14	0,75	3546-1/2X1.5D
5/8	14	0,95	3546-5/8X1.5D
3/4	14	1,13	3546-3/4X1.5D
7/8	14	1,32	3546-7/8X1.5D
1	11	1,50	3546-1X1.5D

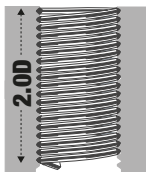
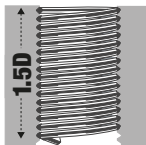

<b>BSP – 2.0D BULK INSERTS</b>			
INSERT			FREE RUNNING
			<b>2.0D</b>
INCH	TPI	INCH	PART #
1/8	28	0,26	3546-1/8X2.0D
1/4	19	0,50	3546-1/4X2.0D
3/8	19	0,76	3546-3/8X2.0D
1/2	14	1,00	3546-1/2X2.0D
5/8	14	1,26	3546-5/8X2.0D
3/4	14	1,50	3546-3/4X2.0D
7/8	14	1,76	3546-7/8X2.0D
1	11	2,00	3546-1X2.0D





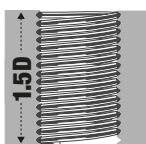

<b>NPT – 1.5D BULK INSERTS</b>			
INSERT			FREE RUNNING
			<b>1.5D</b>
INCH	TPI	INCH	PART #
1/16	27	0,095	3552-1/16X1.5D
1/8	27	0,188	3552-1/8X1.5D
1/4	18	0,375	3552-1/4X1.5D
3/8	18	0,563	3552-3/8X1.5D
1/2	14	0,750	3552-1/2X1.5D
3/4	14	1,125	3552-3/4X1.5D
1	11.5	1,500	3552-1X1.5D









<b>GROUP</b>	<b>PCWI</b>
INSERT TYPE	WIRE THREAD
INSERT MATERIAL	304 STAINLESS STEEL
STYLE	<b>FREE RUNNING</b>





**8-UN – 1.0D BULK INSERTS**

INSERT			FREE RUNNING
			 <b>1.0D</b>
INCH	TPI	INCH	PART #
1-1/8	8	1,13	3570-1.1/8X1.0D
1-1/4	8	1,25	3570-1.1/4X1.0D
1-3/8	8	1,38	3570-1.3/8X1.0D
1-1/2	8	1,50	3570-1.1/2X1.0D
1-5/8	8	1,63	3570-1.5/8X1.0D
1-3/4	8	1,75	3570-1.3/4X1.0D
1-7/8	8	1,88	3570-1.7/8X1.0D
2	8	2,00	3570-2X1.0D





**8-UN – 1.5D BULK INSERTS**

INSERT			FREE RUNNING
			 <b>1.5D</b>
INCH	TPI	INCH	PART #
1-1/8	8	1,70	3570-1.1/8X1.5D
1-1/4	8	1,88	3570-1.1/4X1.5D
1-3/8	8	2,07	3570-1.3/8X1.5D
1-1/2	8	2,25	3570-1.1/2X1.5D
1-5/8	8	2,45	3570-1.5/8X1.5D
1-3/4	8	2,63	3570-1.3/4X1.5D
1-7/8	8	2,82	3570-1.7/8X1.5D
2	8	2,00	3570-2X1.5D





**8-UN – 2.0D BULK INSERTS**

INSERT			FREE RUNNING
			 <b>2.0D</b>
INCH	TPI	INCH	PART #
1/8	28	2,26	3570-1.1/8X2.0D
1/4	19	2,50	3570-1.1/4X2.0D
3/8	19	2,76	3570-1.3/8X2.0D
1/2	14	3,00	3570-1.1/2X2.0D
5/8	14	3,26	3570-1.5/8X2.0D
3/4	14	3,50	3570-1.3/4X2.0D
7/8	14	3,76	3570-1.7/8X2.0D
1	11	2,00	3570-2X2.0D

**BA – 1.5D BULK INSERTS**

INSERT			FREE RUNNING
			 <b>1.5D</b>
INCH	INCH	INCH	PART #
0	0,0394	0,24	3544-0X1.5D
2	0,0319	0,19	3544-2X1.5D
4	0,0260	0,14	3544-4X1.5D
6	0,0209	0,11	3544-6X1.5D

**BSC(B) – 1.5D BULK INSERTS**

INSERT			FREE RUNNING
			 <b>1.5D</b>
INCH	TPI	INCH	PART #
1/4	26	0,38	3560-1/4X1.5D
5/16	26	0,47	3560-5/16X1.5D
3/8	26	0,56	3560-3/8X1.5D
7/16	26	0,66	3560-7/16X1.5D
1/2	26	0,75	3560-1/2X1.5D

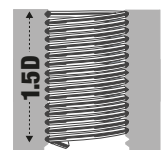











GROUP	PCIR
INSERT TYPE	WIRE THREAD
INSERT MATERIAL	304 STAINLESS STEEL
STYLE	<b>FREE RUNNING</b>



METRIC INSERT		FREE RUNNING					
MM	MM	INSTALLED LENGTH	#	1.0D PART #	1.5D PART #	2.0D PART #	
M2.2	0,45	1,0D	2,20MM	1000	3520-2.20X1.0DIR		
M2.2	0,45	1,5D	3,30MM	1000		3520-2.20X1.5DIR	
M2.2	0,45	2,0D	4,40MM	1000			3520-2.20X2.0DIR
M2.5	0,45	1,0D	2,50MM	1000	3520-2.50X1.0DIR		
M2.5	0,45	1,5D	3,75MM	1000		3520-2.50X1.5DIR	
M2.5	0,45	2,0D	5,00MM	1000			3520-2.50X2.0DIR
M3	0,50	1,0D	3,00MM	1000	3520-3.00X1.0DIR		
M3	0,50	1,5D	4,50MM	1000		3520-3.00X1.5DIR	
M3	0,50	2,0D	6,00MM	1000			3520-3.00X2.0DIR
M4	0,70	1,0D	4,00MM	1000	3520-4.00X1.0DIR		
M4	0,70	1,5D	6,00MM	1000		3520-4.00X1.5DIR	
M4	0,70	2,0D	8,00MM	1000			3520-4.00X2.0DIR
M5	0,80	1,0D	5,00MM	1000	3520-5.00X1.0DIR		
M5	0,80	1,5D	7,50MM	1000		3520-5.00X1.5DIR	
M5	0,80	2,0D	10,00MM	1000			3520-5.00X2.0DIR
M6	1,00	1,0D	6,00MM	500	3520-6.00X1.0DIR		
M6	1,00	1,5D	9,00MM	500		3520-6.00X1.5DIR	
M6	1,00	2,0D	12,00MM	500			3520-6.00X2.0DIR
M8	1,00	1,0D	8,00MM	250	3521-8.00X1.0DIR		
M8	1,00	1,5D	12,00MM	250		3521-8.00X1.5DIR	
M8	1,00	2,0D	16,00MM	250			3521-8.00X2.0DIR
M8	1,25	1,0D	8,00MM	250	3520-8.00X1.0DIR		
M8	1,25	1,5D	12,00MM	250		3520-8.00X1.5DIR	
M8	1,25	2,0D	16,00MM	250			3520-8.00X2.0DIR
M10	1,50	1,0D	10,00MM	250	3520-10.00X1.0DIR		
M10	1,50	1,5D	15,00MM	250		3520-10.00X1.5DIR	
M10	1,50	2,0D	20,00MM	250			3520-10.00X2.0DIR
M12	1,75	1,0D	12,00MM	125	3520-12.00X1.0DIR		
M12	1,75	1,5D	18,00MM	125		3520-12.00X1.5DIR	
M12	1,75	2,0D	24,00MM	125			3520-12.00X2.0DIR



<b>GROUP</b>	<b>PCRP</b>
INSERT TYPE	WIRE THREAD
INSERT MATERIAL	304 STAINLESS STEEL
STYLE	<b>FREE RUNNING</b>

UNC							
INSERT		FREE RUNNING MIL SPEC					
							
INCH	TPI	INSTALLED LENGTH	#	MIL SPEC	PART #	PART #	PART #
<b>2G</b>	56	<b>1,0D</b> 0,09"	1000	MS122095	3532-2GX1.0DIR		
<b>2G</b>	56	<b>1,5D</b> 0,13"	1000	MS122135		3532-2GX1.5DIR	
<b>2G</b>	56	<b>2,0D</b> 0,17"	1000	MS122175			3532-2GX2.0DIR
<b>4G</b>	40	<b>1,0D</b> 0,11"	1000	MS122076	3532-4GX1.0DIR		
<b>4G</b>	40	<b>1,5D</b> 0,17"	1000	MS122116		3532-4GX1.5DIR	
<b>4G</b>	40	<b>2,0D</b> 0,22"	1000	MS122156			3532-4GX2.0DIR
<b>5G</b>	40	<b>1,0D</b> 0,13"	1000	MS122077	3532-5GX1.0DIR		
<b>5G</b>	40	<b>1,5D</b> 0,19"	1000	MS122117		3532-5GX1.5DIR	
<b>5G</b>	40	<b>2,0D</b> 0,25"	1000	MS122157			3532-5GX2.0DIR
<b>6G</b>	32	<b>1,0D</b> 0,14"	1000	MS122078	3532-6GX1.0DIR		
<b>6G</b>	32	<b>1,5D</b> 0,21"	1000	MS122118		3532-6GX1.5DIR	
<b>6G</b>	32	<b>2,0D</b> 0,28"	1000	MS122158			3532-6GX2.0DIR
<b>8G</b>	32	<b>1,0D</b> 0,16"	1000	MS122079	3532-8GX1.0DIR		
<b>8G</b>	32	<b>1,5D</b> 0,25"	1000	MS122119		3532-8GX1.5DIR	
<b>8G</b>	32	<b>2,0D</b> 0,33"	1000	MS122159			3532-8GX2.0DIR
<b>10G</b>	24	<b>1,0D</b> 0,19"	1000	MS122080	3532-10GX1.0DIR		
<b>10G</b>	24	<b>1,5D</b> 0,29"	1000	MS122120		3532-10GX1.5DIR	
<b>10G</b>	24	<b>2,0D</b> 0,38"	1000	MS122160			3532-10GX2.0DIR
<b>12G</b>	24	<b>1,0D</b> 0,22"	500		3532-12GX1.0DIR		
<b>12G</b>	24	<b>1,5D</b> 0,32"	500			3532-12GX1.5DIR	
<b>12G</b>	24	<b>2,0D</b> 0,43"	500				3532-12GX2.0DIR
<b>1/4</b>	20	<b>1,0D</b> 0,25"	500	MS122081	3532-1/4X1.0DIR		
<b>1/4</b>	20	<b>1,5D</b> 0,38"	500	MS122121		3532-1/4X1.5DIR	
<b>1/4</b>	20	<b>2,0D</b> 0,50"	500	MS122161			3532-1/4X2.0DIR
<b>5/16</b>	18	<b>1,0D</b> 0,31"	250	MS122082	3532-5/16X1.0DIR		
<b>5/16</b>	18	<b>1,5D</b> 0,47"	250	MS122122		3532-5/16X1.5DIR	
<b>5/16</b>	18	<b>2,0D</b> 0,62"	250	MS122162			3532-5/16X2.0DIR
<b>3/8</b>	16	<b>1,0D</b> 0,38"	250	MS122083	3532-3/8X1.0DIR		
<b>3/8</b>	16	<b>1,5D</b> 0,57"	250	MS122123		3532-3/8X1.5DIR	
<b>3/8</b>	16	<b>2,0D</b> 0,76"	250	MS122163			3532-3/8X2.0DIR

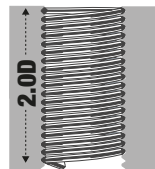
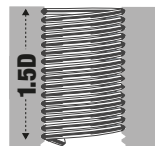



<b>GROUP</b>	<b>PCIR</b>
INSERT TYPE	WIRE THREAD
INSERT MATERIAL	304 STAINLESS STEEL
STYLE	<b>FREE RUNNING</b>



UNF		FREE RUNNING				
INSERT						
INCH	TPI	INSTALLED LENGTH	#	1.0D PART #	1.5D PART #	2.0D PART #
<b>4G</b>	48	<b>1,0D</b> 0,11"	1000	3534-4GX1.0DIR		
<b>4G</b>	48	<b>1,5D</b> 0,17"	1000		3534-4GX1.5DIR	
<b>4G</b>	48	<b>2,0D</b> 0,22"	1000			3534-4GX2.0DIR
<b>6G</b>	40	<b>1,0D</b> 0,14"	1000	3534-6GX1.0DIR		
<b>6G</b>	40	<b>1,5D</b> 0,21"	1000		3534-6GX1.5DIR	
<b>6G</b>	40	<b>2,0D</b> 0,28"	1000			3534-6GX2.0DIR
<b>8G</b>	36	<b>1,0D</b> 0,16"	1000	3534-8GX1.0DIR		
<b>8G</b>	36	<b>1,5D</b> 0,25"	1000		3534-8GX1.5DIR	
<b>8G</b>	36	<b>2,0D</b> 0,33"	1000			3534-8GX2.0DIR
<b>10G</b>	32	<b>1,0D</b> 0,19"	1000	3534-10GX1.0DIR		
<b>10G</b>	32	<b>1,5D</b> 0,29"	1000		3534-10GX1.5DIR	
<b>10G</b>	32	<b>2,0D</b> 0,38"	1000			3534-10GX2.0DIR
<b>1/4</b>	28	<b>1,0D</b> 0,25"	500	3534-1/4X1.0DIR		
<b>1/4</b>	28	<b>1,5D</b> 0,38"	500		3534-1/4X1.5DIR	
<b>1/4</b>	28	<b>2,0D</b> 0,50"	500			3534-1/4X2.0DIR
<b>5/16</b>	24	<b>1,0D</b> 0,31"	250	3534-5/16X1.0DIR		
<b>5/16</b>	24	<b>1,5D</b> 0,47"	250		3534-5/16X1.5DIR	
<b>5/16</b>	24	<b>2,0D</b> 0,62"	250			3534-5/16X2.0DIR
<b>3/8</b>	24	<b>1,0D</b> 0,38"	250	3534-3/8X1.0DIR		
<b>3/8</b>	24	<b>1,5D</b> 0,57"	250		3534-3/8X1.5DIR	
<b>3/8</b>	24	<b>2,0D</b> 0,76"	250			3534-3/8X2.0DIR

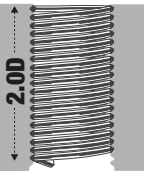
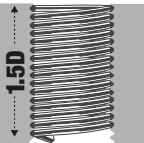











GROUP	PCTP	PCTP	PCIT
MATERIAL	HSS	HSSE	
TOLERANCE	4H5H	4H5H	4H5H
TYPE	STI	STI	STI

**METRIC COARSE – STI TAPS AND GAUGES**

TO SUIT INSERT			HAND & MACHINE TAPS			MACHINE TAPS		GO NO-GO
MM	MM	MM	PART #	PART #	PART #	PART #	PART #	PART #
M2	0,40	44,50	3520-2.00T	3520-2.00I	3520-2.00B	3520-2.00SP	3520-2.00SF	3520-2.00GC
M2.2	0,45	44,50	3520-2.20T	3520-2.20I	3520-2.20B	3520-2.20SP	3520-2.20SF	3520-2.20GC
M2.5	0,45	48,00	3520-2.50T	3520-2.50I	3520-2.50B	3520-2.50SP	3520-2.50SF	3520-2.50GC
M3	0,50	53,00	3520-3.00T	3520-3.00I	3520-3.00B	3520-3.00SP	3520-3.00SF	3520-3.00GC
M3.5	0,60	53,00	3520-3.50T	3520-3.50I	3520-3.50B	3520-3.50SP	3520-3.50SF	3520-3.50GC
M4	0,70	58,00	3520-4.00T	3520-4.00I	3520-4.00B	3520-4.00SP	3520-4.00SF	3520-4.00GC
M5	0,80	66,00	3520-5.00T	3520-5.00I	3520-5.00B	3520-5.00SP	3520-5.00SF	3520-5.00GC
M6	1,00	72,00	3520-6.00T	3520-6.00I	3520-6.00B	3520-6.00SP	3520-6.00SF	3520-6.00GC
M7	1,00	72,00	3520-7.00T	3520-7.00I	3520-7.00B	3520-7.00SP	3520-7.00SF	
M8	1,25	80,00	3520-8.00T	3520-8.00I	3520-8.00B	3520-8.00SP	3520-8.00SF	3520-8.00GC
M9	1,25	85,00	3520-9.00T	3520-9.00I	3520-9.00B			
M10	1,50	89,00	3520-10.00T	3520-10.00I	3520-10.00B	3520-10.00SP	3520-10.00SF	3520-10.00GC
M11	1,50	89,00	3520-11.00T	3520-11.00I	3520-11.00B	3520-11.00SP	3520-11.00SF	3520-11.00GC
M12	1,75	95,00	3520-12.00T	3520-12.00I	3520-12.00B	3520-12.00SP	3520-12.00SF	3520-12.00GC
M13	1,75	95,00	3520-13.00T	3520-13.00I	3520-13.00B			3520-13.00GC
M14	2,00	102,00	3520-14.00T	3520-14.00I	3520-14.00B	3520-14.00SP	3520-14.00SF	3520-14.00GC
M15	2,00	112,00	3520-15.00T	3520-15.00I	3520-15.00B			3520-15.00GC
M16	2,00	112,00	3520-16.00T	3520-16.00I	3520-16.00B	3520-16.00SP	3520-16.00SF	3520-16.00GC
M18	2,50	118,00	3520-18.00T	3520-18.00I	3520-18.00B	3520-18.00SP	3520-18.00SF	3520-18.00GC
M20	2,50	118,00	3520-20.00T	3520-20.00I	3520-20.00B	3520-20.00SP	3520-20.00SF	3520-20.00GC
M22	2,50	130,00	3520-22.00T	3520-22.00I	3520-22.00B	3520-22.00SP	3520-22.00SF	3520-22.00GC
M24	3,00	138,00	3520-24.00T	3520-24.00I	3520-24.00B	3520-24.00SP	3520-24.00SF	3520-24.00GC
M27	3,00	151,00		3520-27.00I				
M30	3,50	162,00		3520-30.00I		3520-30.00SP	3520-30.00SF	
M33	3,50	162,00		3520-33.00I		3520-33.00SP	3520-33.00SF	
M36	4,00	170,00		3520-36.00I				

GROUP	PCTP	PCTP	PCIT
MATERIAL	HSS	HSSE	
TOLERANCE	4H5H	4H5H	4H5H
TYPE	STI	STI	STI





**METRIC FINE – STI TAPS AND GAUGES**

TO SUIT INSERT			HAND & MACHINE TAPS			MACHINE TAPS		GO NO-GO
								
MM	MM	MM	PART #	PART #	PART #	PART #	PART #	PART #
M8	1,00	80,00	3521-8.00T	3521-8.00I	3521-8.00B	3521-8.00SP	3521-8.00SF	3521-8.00GC
M10	1,25	85,00	3521-10.00T	3521-10.00I	3521-10.00B	3521-10.00SP	3521-10.00SF	3521-10.00GC
M10	1,00	85,00	3523-10.00T	3523-10.00I	3523-10.00B	3523-10.00SP	3523-10.00SF	3523-10.00GC
M11	1,25	88,00	3521-11.00T	3521-11.00I	3521-11.00B			3521-11.00GC
M11	1,00	88,00	3523-11.00T	3523-11.00I	3523-11.00B			3523-11.00GC
M12	1,50	95,00	3521-12.00T	3521-12.00I	3521-12.00B	3521-12.00SP	3521-12.00SF	3521-12.00GC
M12	1,25	95,00	3523-12.00T	3523-12.00I	3523-12.00B	3523-12.00SP	3523-12.00SF	3523-12.00GC
M12	1,00	95,00	3524-12.00T	3524-12.00I	3524-12.00B			
M13	1,25	95,00	3523-13.00T	3523-13.00I	3523-13.00B			3523-13.00GC
M14	1,50	102,00	3521-14.00T	3521-14.00I	3521-14.00B	3521-14.00SP	3521-14.00SF	3521-14.00GC
M14	1,25	102,00	3523-14.00T	3523-14.00I	3523-14.00B	3523-14.00SP	3523-14.00SF	
M14	1,00	102,00	3524-14.00T	3524-14.00I	3524-14.00B			
M15	1,50	104,00	3521-15.00T	3521-15.00I	3521-15.00B			3521-15.00GC
M16	1,50	104,00	3521-16.00T	3521-16.00I	3521-16.00B			3521-16.00GC
M18	2,00	104,00	3521-18.00T	3521-18.00I	3521-18.00B			3521-18.00GC
M18	1,50	104,00	3523-18.00T	3523-18.00I	3523-18.00B			3523-18.00GC
M20	2,00	113,00	3521-20.00T	3521-20.00I	3521-20.00B			3521-20.00GC
M20	1,50	113,00	3523-20.00T	3523-20.00I	3523-20.00B			3523-20.00GC
M22	2,00	120,00	3521-22.00T	3521-22.00I	3521-22.00B			3521-22.00GC
M22	1,50	120,00	3523-22.00T	3523-22.00I	3523-22.00B			3523-22.00GC
M24	2,00	127,00	3521-24.00T	3521-24.00I	3521-24.00B			3521-24.00GC
M24	1,50	127,00	3523-24.00T	3523-24.00I	3523-24.00B			3523-24.00GC
M26	1,50	127,00	3523-26.00T	3523-26.00I	3523-26.00B			
M27	2,00	127,00	3521-27.00T	3521-27.00I	3521-27.00B			
M27	1,50	127,00	3523-27.00T	3523-27.00I	3523-27.00B			
M28	1,50	127,00	3523-28.00T	3523-28.00I	3523-28.00B			
M30	2,00	137,00	3521-30.00T	3521-30.00I	3521-30.00B			
M30	1,50	137,00	3523-30.00T	3523-30.00I	3523-30.00B			
M33	2,00	144,00	3521-33.00T	3521-33.00I	3521-33.00B			
M36	3,00	170,00	3521-36.00T	3521-36.00I	3521-36.00B			
M36	2,00	150,00	3523-36.00T	3523-36.00I	3523-36.00B			
M36	1,50	150,00	3524-36.00T	3524-36.00I	3524-36.00B			

GROUP	PCTP
MATERIAL	HSS
TOLERANCE	4H5H
TYPE	STI



**SPARK PLUG – PILOT NOSE STI TAPS**

TO SUIT INSERT			HAND TAPS
			
MM	MM	MM	PART #
M6	1,00	70,00	3520-6.00PN
M8	1,25	75,00	3520-8.00PN
M10	1,50	80,00	3520-10.00PN
M10	1,00	74,00	3522-10.00PN
M12	1,25	75,00	3522-12.00PN
M14	1,25	90,00	3522-14.00PN
M18	1,50	116,00	3522-18.00PN





GROUP	PCTP	PCTP	PCIT
MATERIAL	HSS	HSSE	
TOLERANCE	3B	3B	3B
TYPE	STI	STI	STI







**UNC – STI TAPS AND GAUGES**







TO SUIT INSERT			HAND & MACHINE TAPS			MACHINE TAPS		GO NO-GO
INCH	TPI	MM	PART #	PART #	PART #	PART #	PART #	PART #
2G	56	48,00	3532-2GT	3532-2GI	3532-2GB	3532-2GSP	3532-2GSF	3532-2GGC
3G	48	48,00	3532-3GT	3532-3GI	3532-3GB	3532-3GSP	3532-3GSF	3532-3GGC
4G	40	53,00	3532-4GT	3532-4GI	3532-4GB	3532-4GSP	3532-4GSF	3532-4GGC
5G	40	53,00	3532-5GT	3532-5GI	3532-5GB	3532-5GSP	3532-5GSF	3532-5GGC
6G	32	58,00	3532-6GT	3532-6GI	3532-6GB	3532-6GSP	3532-6GSF	3532-6GGC
8G	32	62,00	3532-8GT	3532-8GI	3532-8GB	3532-8GSP	3532-8GSF	3532-8GGC
10G	24	66,00	3532-10GT	3532-10GI	3532-10GB	3532-10GSP	3532-10GSF	3532-10GGC
12G	24	66,00	3532-12GT	3532-12GI	3532-12GB	3532-12GSP	3532-12GSF	3532-12GGC
1/4	20	72,00	3532-1/4T	3532-1/4I	3532-1/4B	3532-1/4SP	3532-1/4SF	3532-1/4GC
5/16	18	80,00	3532-5/16T	3532-5/16I	3532-5/16B	3532-5/16SP	3532-5/16SF	3532-5/16GC
3/8	16	85,00	3532-3/8T	3532-3/8I	3532-3/8B	3532-3/8SP	3532-3/8SF	3532-3/8GC
7/16	14	95,00	3532-7/16T	3532-7/16I	3532-7/16B	3532-7/16SP	3532-7/16SF	3532-7/16GC
1/2	13	102,00	3532-1/2T	3532-1/2I	3532-1/2B	3532-1/2SP	3532-1/2SF	3532-1/2GC
9/16	12	112,00	3532-9/16T	3532-9/16I	3532-9/16B			
5/8	11	112,00	3532-5/8T	3532-5/8I	3532-5/8B	3532-5/8SP	3532-5/8SF	3532-5/8GC
3/4	10	118,00	3532-3/4T	3532-3/4I	3532-3/4B	3532-3/4SP	3532-3/4SF	3532-3/4GC
7/8	9	130,00	3532-7/8T	3532-7/8I	3532-7/8B	3532-7/8SP	3532-7/8SF	3532-7/8GC
1	8	138,00	3532-1T	3532-1I	3532-1B	3532-1SP	3532-1SF	3532-1GC
1-1/8	7	151,00	3532-1.1/8T	3532-1.1/8I	3532-1.1/8B			
1-1/4	7	162,00	3532-1.1/4T	3532-1.1/4I	3532-1.1/4B			
1-3/8	6	170,00	3532-1.3/8T	3532-1.3/8I	3532-1.3/8B			
1-1/2	6	187,00	3532-1.1/2T	3532-1.1/2I	3532-1.1/2B			







**UNF – STI TAPS AND GAUGES**

TO SUIT INSERT			HAND & MACHINE TAPS			MACHINE TAPS		GO NO-GO
INCH	TPI	MM	PART #	PART #	PART #	PART #	PART #	PART #
3G	56	48,00	3534-3GT	3534-3GI	3534-3GB	3534-3GSP	3534-3GSF	3534-3GGC
4G	48	53,00	3534-4GT	3534-4GI	3534-4GB	3534-4GSP	3534-4GSF	3534-4GGC
6G	40	53,00	3534-6GT	3534-6GI	3534-6GB	3534-6GSP	3534-6GSF	3534-6GGC
8G	36	62,00	3534-8GT	3534-8GI	3534-8GB	3534-8GSP	3534-8GSF	3534-8GGC
10G	32	66,00	3534-10GT	3534-10GI	3534-10GB	3534-10GSP	3534-10GSF	3534-10GGC
12G	28	66,00	3534-12GT	3534-12GI	3534-12GB	3534-12GSP	3534-12GSF	3534-12GGC
1/4	28	69,00	3534-1/4T	3534-1/4I	3534-1/4B	3534-1/4SP	3534-1/4SF	3534-1/4GC
5/16	24	76,00	3534-5/16T	3534-5/16I	3534-5/16B	3534-5/16SP	3534-5/16SF	3534-5/16GC
3/8	24	82,00	3534-3/8T	3534-3/8I	3534-3/8B	3534-3/8SP	3534-3/8SF	3534-3/8GC
7/16	20	84,00	3534-7/16T	3534-7/16I	3534-7/16B	3534-7/16SP	3534-7/16SF	3534-7/16GC
1/2	20	90,00	3534-1/2T	3534-1/2I	3534-1/2B	3534-1/2SP	3534-1/2SF	3534-1/2GC
9/16	18	104,00	3534-9/16T	3534-9/16I	3534-9/16B	3534-9/16SP	3534-9/16SF	
5/8	18	104,00	3534-5/8T	3534-5/8I	3534-5/8B	3534-5/8SP	3534-5/8SF	3534-5/8GC
3/4	16	104,00	3534-3/4T	3534-3/4I	3534-3/4B	3534-3/4SP	3534-3/4SF	3534-3/4GC
7/8	14	120,00	3534-7/8T	3534-7/8I	3534-7/8B	3534-7/8SP	3534-7/8SF	3534-7/8GC
1	12	127,00	3534-1T	3534-1I	3534-1B	3534-1SP	3534-1SF	3534-1GC
1	14	127,00	3535-1T	3535-1I	3535-1B	3535-1SP	3535-1SF	3535-1GC
1-1/8	12	137,00	3534-1.1/8T	3534-1.1/8I	3534-1.1/8B			
1-1/4	12	144,00	3534-1.1/4T	3534-1.1/4I	3534-1.1/4B			
1-3/8	12	150,00	3534-1.3/8T	3534-1.3/8I	3534-1.3/8B			
1-1/2	12	150,00	3534-1.1/2T	3534-1.1/2I	3534-1.1/2B			

<b>GROUP</b>	<b>PCTP</b>
MATERIAL	HSS
TOLERANCE	3B
TYPE	<b>STI</b>

<b>BSW – STI TAPS</b>					
<b>TO SUIT INSERT</b>			<b>HAND &amp; MACHINE TAPS</b>		
					
INCH	TPI	MM	PART #	PART #	PART #
1/8	40	53,00	3528-1/8T	3528-1/8I	3528-1/8B
3/16	24	56,00	3528-3/16T	3528-3/16I	3528-3/16B
1/4	20	72,00	3528-1/4T	3528-1/4I	3528-1/4B
5/16	18	80,00	3528-5/16T	3528-5/16I	3528-5/16B
3/8	16	85,00	3528-3/8T	3528-3/8I	3528-3/8B
7/16	14	95,00	3528-7/16T	3528-7/16I	3528-7/16B
1/2	12	102,00	3528-1/2T	3528-1/2I	3528-1/2B
9/16	12	102,00	3528-9/16T	3528-9/16I	3528-9/16B
5/8	11	112,00	3528-5/8T	3528-5/8I	3528-5/8B
11/16	11	112,00	3528-11/16T	3528-11/16I	3528-11/16B
3/4	10	118,00	3528-3/4T	3528-3/4I	3528-3/4B
7/8	9	130,00	3528-7/8T	3528-7/8I	3528-7/8B
1	8	138,00	3528-1T	3528-1I	3528-1B

<b>BSF – STI TAPS</b>					
<b>TO SUIT INSERT</b>			<b>HAND &amp; MACHINE TAPS</b>		
					
INCH	TPI	MM	PART #	PART #	PART #
3/16	32	66,00	3530-3/16T	3530-3/16I	3530-3/16B
1/4	26	72,00	3530-1/4T	3530-1/4I	3530-1/4B
5/16	22	80,00	3530-5/16T	3530-5/16I	3530-5/16B
3/8	20	85,00	3530-3/8T	3530-3/8I	3530-3/8B
7/16	18	89,00	3530-7/16T	3530-7/16I	3530-7/16B
1/2	16	95,00	3530-1/2T	3530-1/2I	3530-1/2B
9/16	16	102,00	3530-9/16T	3530-9/16I	3530-9/16B
5/8	14	112,00	3530-5/8T	3530-5/8I	3530-5/8B
11/16	14	112,00	3530-11/16T	3530-11/16I	3530-11/16B
3/4	12	118,00	3530-3/4T	3530-3/4I	3530-3/4B
7/8	11	130,00	3530-7/8T	3530-7/8I	3530-7/8B
1	10	138,00	3530-1T	3530-1I	3530-1B

<b>BSP – STI TAPS</b>					
<b>TO SUIT INSERT</b>			<b>HAND &amp; MACHINE TAPS</b>		
					
INCH	TPI	MM	PART #	PART #	PART #
1/8	28	59,00	3546-1/8T	3546-1/8I	3546-1/8B
1/4	19	67,00	3546-1/4T	3546-1/4I	3546-1/4B
3/8	19	75,00	3546-3/8T	3546-3/8I	3546-3/8B
1/2	14	87,00	3546-1/2T	3546-1/2I	3546-1/2B
5/8	14	91,00	3546-5/8T	3546-5/8I	3546-5/8B
3/4	14	96,00	3546-3/4T	3546-3/4I	3546-3/4B
1	11	109,00	3546-1T	3546-1I	3546-1B



GROUP	PCTP
MATERIAL	HSS
TOLERANCE	3B
TYPE	STI

**NPT – STI TAPS**

TO SUIT INSERT			HAND & MACHINE TAPS		
INCH	TPI	MM	PART #	PART #	PART #
1/8	27	54,00	3552-1/8T	3552-1/8I	3552-1/8B
1/4	18	62,00	3552-1/4T	3552-1/4I	3552-1/4B
3/8	18	65,00	3552-3/8T	3552-3/8I	3552-3/8B
1/2	14	80,00	3552-1/2T	3552-1/2I	3552-1/2B
3/4	14	83,00	3552-3/4T	3552-3/4I	3552-3/4B
1	11,5	95,00	3552-1T	3552-1I	3552-1B

**8-UN – STI TAPS**

TO SUIT INSERT			HAND & MACHINE TAPS		
INCH	TPI	MM	PART #	PART #	PART #
1-1/8	8	151,00	3570-1.1/8T	3570-1.1/8I	3570-1.1/8B
1-1/4	8	162,00	3570-1.1/4T	3570-1.1/4I	3570-1.1/4B
1-3/8	8	170,00	3570-1.3/8T	3570-1.3/8I	3570-1.3/8B
1-1/2	8	170,00	3570-1.1/2T	3570-1.1/2I	3570-1.1/2B
1-5/8	8	187,00	3570-1.5/8T	3570-1.5/8I	3570-1.5/8B
1-3/4	8	187,00	3570-1.3/4T	3570-1.3/4I	3570-1.3/4B
1-7/8	8	200,00	3570-1.7/8T	3570-1.7/8I	3570-1.7/8B
2	8	200,00	3570-2T	3570-2I	3570-2B

**BSC(B) – STI TAPS**

TO SUIT INSERT			HAND & MACHINE TAPS		
INCH	TPI	MM	PART #	PART #	PART #
1/4	26	69,00	3560-1/4T	3560-1/4I	3560-1/4B
5/16	26	76,00	3560-5/16T	3560-5/16I	3560-5/16B
3/8	26	82,00	3560-3/8T	3560-3/8I	3560-3/8B
7/16	26	84,00	3560-7/16T	3560-7/16I	3560-7/16B
1/2	26	90,00	3560-1/2T	3560-1/2I	3560-1/2B

**BA – STI TAPS**

TO SUIT INSERT			HAND & MACHINE TAPS		
#	INCH	MM	PART #	PART #	PART #
0	0,0394	66,00	3544-0T	3544-0I	3544-0B
2	0,0319	66,00	3544-2T	3544-2I	3544-2B
4	0,0260	53,00	3544-4T	3544-4I	3544-4B
6	0,0209	50,00	3544-6T	3544-6I	3544-6B



GROUP	PCIT
USAGE	GENERAL
INSERT TYPE	WIRE THREAD
INSERT STYLE	<b>FREE RUNNING</b>
APPLICATION	<b>LOW VOLUME</b>

**HAND INSTALLATION TOOLS – HIT**

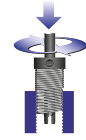

MC	MF	SPARK	UNC	UNF	BSW	BSF	BA	BSC	NPT	BSP	UN-8	PART #
M2X0.4												3500-HIT2
M2.2X0.45			2G-56									3500-HIT2
M2.5X0.45			3G-48	3G-56			#6					3500-HIT3
M3X0.5			4G-40	4G-48	1/8-40							3500-HIT4
			5G-40									3500-HIT4
M3X0.6			6G-32	6G-40			#4					3500-HIT5
M4X0.7			8G-32	8G-36								3500-HIT6
			10G-24		3/16-24		#2					3500-HIT7
M5X0.8			12G-24	10G-32		3/16-32						3500-HIT8
				12G-28								3500-HIT8
M6X1			1/4-20	1/4-28	1/4-20	1/4-26	#0	1/4-26				3500-HIT9
M7X1			5/16-18		5/16-18				1/16-27			3500-HIT10
M8X1.25	M8X1			5/16-24	3/8-16	5/16-22		5/16-26				3500-HIT11
M9X1.25	M10X1.25	M10X1	3/8-16	3/8-24		3/8-20		3/8-26				3500-HIT13
M9X1	M10X1											3500-HIT13
M10X1.5									1/8-27			3500-HIT13
M11X1.5	M11X1.25		7/16-14	7/16-20	7/16-14	7/16-18		7/16-26		1/8-28		3500-HIT14
	M11X1			7/16-16								3500-HIT14
M12X1.75	M12X1.5	M10X1.25	1/2-13	1/2-20	1/2-12	1/2-16		1/2-26				3500-HIT15
M12X1	M12X1.25											3500-HIT15
M14X2	M14X1		9/16-12	9/16-18	9/16-12	9/16-16				1/4-19		3500-HIT16
M15X2	M14X1.5								1/4-18			3500-HIT16
		M14X1.25										3500-HIT17
M16X2	M16X1.5		5/8-11	5/8-18	5/8-11	5/8-14			3/8-18			3500-HIT18
M18X2.5	M18X2	M18X1.5	3/4-10		3/4-10	3/4-12				3/8-19		3500-HIT20
	M18X1.5											3500-HIT20
M20X2.5	M20X2			3/4-16								3500-HIT21
	M20X1.5											3500-HIT21
M22X2.5	M22X2		7/8-9	7/8-14	7/8-9	7/8-11			1/2-14			3500-HIT22
	M22X1.5											3500-HIT22
M24X3	M24X2		1-8	1-12	1-8	1-10				1/2-14		3500-HIT23
	M24X1.5			1-14						5/8-14		3500-HIT23
M27X3	M26X1.5								3/4-14	3/4-14		3500-HIT24
M30X3			1.1/8-7	1.1/8-12							1.1/8-8	3500-HIT25
M33X3.5	M30X2		1.1/4-7	1.1/4-12							1.1/4-8	3500-HIT26
			1.3/8-6	1.3/8-12					1-11,5	7/8-14	1.3/8-8	3500-HIT27
										1-11		3500-HIT27
M36X4	M36X2		1.1/2-6	1.1/2-12							1.1/2-8	3500-HIT28
											1.5/8-8	3500-HIT28
											1.3/4-8	3500-HIT28
											1.7/8-8	3500-HIT30
											2-8	3500-HIT30



GROUP	PCIT
USAGE	GENERAL
INSERT TYPE	WIRE THREAD
INSERT STYLE	ALL
APPLICATION	LOW VOLUME

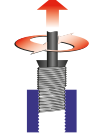

**TANG BREAK TOOLS – TB : INSERT REMOVAL TOOLS – RT**

MC	MF	SPARK	UNC	UNF	BSW	BSF	BA	BSC		
									<b>PART #</b>	<b>PART #</b>
M2X0.4									3500-TB1	3500-RT1
M2.2X0.45			2G-56						3500-TB2	3500-RT1
M2.5X0.45			3G-48	3G-56			#6		3500-TB3	3500-RT1
			4G-40	4G-48	1/8-40				3500-TB4	3500-RT1
M3X0.5			5G-40						3500-TB4	3500-RT2
									3500-TB4	3500-RT1
M3.5X0.6			6G-32	6GX40			#4		3500-TB5	3500-RT2
						3/16-32			3500-TB5	3500-RT1
M4X0.7			8G-32	8G-36					3500-TB6	3500-RT2
			10G-24	10G-32	3/16-24		#2		3500-TB6	3500-RT1
M5X0.8			12G-24	12G-28					3500-TB8	3500-RT2
									3500-TB8	3500-RT2
M6X1			1/4-20	1/4-28	1/4-20	1/4-26		1/4-26	3500-TB9	3500-RT2
M7X1					5/16-18	5/16-22	#0		3500-TB11	3500-RT2
M8X1.25	M8X1		5/16-18	5/16-24				5/16-26	3500-TB12	3500-RT2
M9X1.25	M9X1	M10X1							3500-TB12	3500-RT2
			3/8-16		3/8-16	3/8-20			3500-TB12	3500-RT3
M10X1.5	M10X1.25								3500-TB13	3500-RT2
				3/8-24				3/8-26	3500-TB13	3500-RT3
	M10X1								3500-TB13	3500-RT2
M11X1.5	M11X1.25		7/16-14	7/16-20	7/16-14	7/16-18		7/16-26	3500-TB14	3500-RT3
	M11X1								3500-TB14	3500-RT3
M12X1.75	M12X1.5	M10X1.25	1/2-13	1/2-20	1/2-12	1/2-16		1/2-26	3500-TB15	3500-RT3
	M12X1	M12X1.25							3500-TB15	3500-RT3
M13X1.75	M13X1.5								3500-TB15	3500-RT3
	M13X1.25									3500-RT3
M14X2	M14X1.5	M14X1.25	9/16-12	9/16-18	9/16-12	9/16-16				3500-RT3
	M14X1									3500-RT3
M15X2	M15X1.5									3500-RT3
M16X2	M16X1.5		5/8-11	5/8-18	5/8-11	5/8-14				3500-RT3
M18X2.5	M18X2	M18X1.5	3/4-10		3/4-10	3/4-12				3500-RT3
M20X2.5	M20X2			3/4-16						3500-RT3
	M20X1.5									3500-RT3
M22X2.5	M22X2		7/8-9	7/8-14	7/8-9	7/8-11				3500-RT3
	M22X1.5									3500-RT3
M24X3	M24X2		1-8	1-12	1-8	1-10				3500-RT3
	M24X1.5			1-14						3500-RT3
	M26X1.5									3500-RT4
M27X3	M27X2									3500-RT4
	M27X1.5									3500-RT4
	M28X1.5									3500-RT4
M30X3.5	M30X2		1.1/8-7	1.1/8-12						3500-RT4
	M30X1.5		1.1/4-7	1.1/4-12						3500-RT4
M33X3.5	M33X2		1.3/8-6	1.3/8-12						3500-RT4
M36X4	M36X3		1.1/2-6	1.1/2-12						3500-RT4
	M36X2									3500-RT4
	M36X1.5									3500-RT4



Note: For larger insert sizes, where a TB (Tang Break) tool is not listed, the tang break operation is performed using the HIT (Hand Installation Tool).



GROUP	PCIT
USAGE	GENERAL
INSERT TYPE	WIRE THREAD
INSERT STYLE	ALL
APPLICATION	MED. VOLUME



MACHINE INSTALLATION TOOLS – MIT : PREWINDER TOOLS – HIP : SPRING LOADED TANG BREAK TOOLS – STB					
MC	MF	SPARK	PART #	PART #	PART #
M2X0.4			3520-2.00MIT	3520-2.00HIP	3500-STB1
M2.2X0.45			3520-2.20MIT	3520-2.20HIP	3500-STB1
M2.5X0.45			3520-2.50MIT	3520-2.50HIP	3500-STB2
M3X0.5			3520-3.00MIT	3520-3.00HIP	3500-STB4
M3.5X0.6			3520-3.50MIT	3520-3.50HIP	3500-STB4
M4X0.7			3520-4.00MIT	3520-4.00HIP	3500-STB5
M5X0.8			3520-5.00MIT	3520-5.00HIP	3500-STB6
M6X1			3520-6.00MIT	3520-6.00HIP	3500-STB8
M7X1			3520-7.00MIT	3520-7.00HIP	
M8X1.25			3520-8.00MIT	3520-8.00HIP	3500-STB9
	M8X1		3521-8.00MIT	3521-8.00HIP	3500-STB9
M10X1.5			3520-10.00MIT	3520-10.00HIP	3500-STB10
	M10X1.25		3521-10.00MIT	3521-10.00HIP	3500-STB10
	M10X1		3523-10.00MIT	3523-10.00HIP	3500-STB10
M11X1.5			3520-11.00MIT	3520-11.00HIP	
M12X1.75			3520-12.00MIT	3520-12.00HIP	3500-STB12
	M12X1.5		3521-12.00MIT	3521-12.00HIP	3500-STB12
		M12X1.25	3523-12.00MIT	3523-12.00HIP	3500-STB12
	M12X1				3500-STB12
M14X2			3520-14.00MIT	3520-14.00HIP	
	M14X1.5		3521-14.00MIT	3521-14.00HIP	
		M14X1.25	3523-14.00MIT	3523-14.00HIP	
M16X2			3520-16.00MIT	3520-16.00HIP	
	M16X1.5		3521-16.00MIT	3521-16.00HIP	

## PowerCoil Installation and Extraction Tools

### HIT Hand Installation Tool

The most flexible and cost effective installation tool for small volume applications – free running inserts only.

### TB Tang Break Tool

Used to break the tang off inserts up to M13 or 1/2". Over these sizes and up to M24 or 1" the HIT tool is used to both install and break the tang.

### RT Removal Tool

A quick and simple way to remove inserts up to M36 or 1.1/2" in diameter.

### MIT Machine Installation Tool

1/4" hex shank tool suitable for use with electric and cordless tools. Ideal for medium volume installation using bulk free running and screw locking inserts.

### HIP Hand Installation Prewinder Tool

For simplified installation of bulk free running and screw locking inserts in low to medium volume applications. HIP tools are ideal for installing MIL spec inserts.

### STB Spring Loaded Tang Break Tool

Spring loaded tang break tools increase the efficiency of the tang break procedure in medium to high volume applications.

### MIP Machine Installation – Pneumatic

The use of Front End Assemblies with Pneumatic Tools provides maximum efficiency in high volume applications when using strip feed free running and screw locking inserts.

GROUP	PCIT
USAGE	GENERAL
INSERT TYPE	WIRE THREAD
INSERT STYLE	ALL
APPLICATION	MED. VOLUME



**MACHINE INSTALLATION TOOLS – MIT : PREWINDER TOOLS – HIP : SPRING LOADED TANG BREAK TOOLS – STB**

UNC	UNF	MIT	PREWINDER TOOLS	HIP	SPRING LOADED TANG BREAK TOOLS
UNC	UNF	PART #	PART #	PART #	PART #
2G-56		3532-2GMIT	3532-2GHIP	3500-STB1	
3G-48			3532-3GHIP		
	3G-56		3534-3GHIP		
4G-40		3532-4GMIT	3532-4GHIP	3500-STB3	
	4G-48	3534-4GMIT	3534-4GHIP	3500-STB3	
5G-40		3532-5GMIT	3532-5GHIP	3500-STB3	
6G-32		3532-6GMIT	3532-6GHIP	3500-STB4	
	6G-40	3534-6GMIT	3534-6GHIP	3500-STB4	
8G-32		3532-8GMIT	3532-8GHIP	3500-STB5	
	8G-36	3534-8GMIT	3534-8GHIP	3500-STB5	
10G-24		3532-10GMIT	3532-10GHIP	3500-STB6	
	10G-32	3534-10GMIT	3534-10GHIP	3500-STB6	
12G-24		3532-12GMIT	3532-12GHIP	3500-STB7	
	12G-28		3534-12GHIP	3500-STB7	
1/4-20		3532-1/4MIT	3532-1/4HIP	3500-STB8	
	1/4-28	3534-1/4MIT	3534-1/4HIP	3500-STB8	
5/16-18		3532-5/16MIT	3532-5/16HIP	3500-STB9	
	5/16-24	3534-5/16MIT	3534-5/16HIP	3500-STB9	
3/8-16		3532-3/8MIT	3532-3/8HIP	3500-STB10	
	3/8-24	3534-3/8MIT	3534-3/8HIP	3500-STB10	
7/16-14		3532-7/16MIT	3532-7/16HIP	3500-STB11	
	7/16-20	3534-7/16MIT	3534-7/16HIP	3500-STB11	
1/2-13		3532-1/2MIT	3532-1/2HIP	3500-STB12	
	1/2-20	3534-1/2MIT	3534-1/2HIP	3500-STB12	

GROUP	PCIT
USAGE	GENERAL
INSERT TYPE	WIRE THREAD
INSERT STYLE	ALL
APPLICATION	HIGH VOLUME



FRONT END ASSEMBLY - FEA



FEA MANDREL







FEA NOZZLE







PNEUMATIC INSTALLATION TOOL

**PNEUMATIC TOOLS AND FRONT END ASSEMBLIES**

MC	MF	 PART #	 PART #	 PART #	 PART #
M2X0.4		3520-2.20MIP	3520-2.20MIPM	3520-2.20MIPN	3500-MIP1
M2.5X0.45		3520-2.50MIP	3520-2.50MIPM	3520-2.50MIPN	3500-MIP1
M3X0.5		3520-3.00MIP	3520-3.00MIPM	3520-3.00MIPN	3500-MIP1
M3.5X0.6		3520-3.50MIP	3520-3.50MIPM	3520-3.50MIPN	3500-MIP1
M4X0.7		3520-4.00MIP	3520-4.00MIPM	3520-4.00MIPN	3500-MIP1
M5X0.8		3520-5.00MIP	3520-5.00MIPM	3520-5.00MIPN	3500-MIP1
M6X1		3520-6.00MIP	3520-6.00MIPM	3520-6.00MIPN	3500-MIP1
M8X1.25		3520-8.00MIP	3520-8.00MIPM	3520-8.00MIPN	3500-MIP2
	M8X1	3521-8.00MIP	3521-8.00MIPM	3521-8.00MIPN	3500-MIP2
M10X1.5		3520-10.00MIP	3520-10.00MIPM	3520-10.00MIPN	3500-MIP2
	M10X1.25	3521-10.00MIP	3521-10.00MIPM	3521-10.00MIPN	3500-MIP2
	M10X1	3523-10.00MIP	3523-10.00MIPM	3523-10.00MIPN	3500-MIP2
M12X1.75		3520-12.00MIP	3520-12.00MIPM	3520-12.00MIPN	3500-MIP2
	M12X1.5	3521-12.00MIP	3521-12.00MIPM	3521-12.00MIPN	3500-MIP2
	M12X1.25	3523-12.00MIP	3523-12.00MIPM	3523-12.00MIPN	3500-MIP2

**PNEUMATIC TOOLS AND FRONT END ASSEMBLIES**

UNC	UNF	 PART #	 PART #	 PART #	 PART #
2G-56		3532-2GMIP	3532-2GMIPM	3532-2GMIPN	3500-MIP1
4G-40		3532-4GMIP	3532-4GMIPM	3532-4GMIPN	3500-MIP1
5G-40		3532-5GMIP	3532-5GMIPM	3532-5GMIPN	3500-MIP1
6G-32		3532-6GMIP	3532-6GMIPM	3532-6GMIPN	3500-MIP1
	6G-40	3534-6GMIP	3534-6GMIPM	3534-6GMIPN	3500-MIP1
8G-32		3532-8GMIP	3532-8GMIPM	3532-8GMIPN	3500-MIP1
	8G-36	3534-8GMIP	3534-8GMIPM	3534-8GMIPN	3500-MIP1
10G-24		3532-10GMIP	3532-10GMIPM	3532-10GMIPN	3500-MIP1
	10G-32	3534-10GMIP	3534-10GMIPM	3534-10GMIPN	3500-MIP1
12G-24		3532-12GMIP	3532-12GMIPM	3532-12GMIPN	3500-MIP1
1/4-20		3532-1/4MIP	3532-1/4MIPM	3532-1/4MIPN	3500-MIP1
	1/4-28	3534-1/4MIP	3534-1/4MIPM	3534-1/4MIPN	3500-MIP1
5/16-18		3532-5/16MIP	3532-5/16MIPM	3532-5/16MIPN	3500-MIP2
	5/16-24	3534-5/16MIP	3534-5/16MIPM	3534-5/16MIPN	3500-MIP2
3/8-16		3532-3/8MIP	3532-3/8MIPM	3532-3/8MIPN	3500-MIP2
	3/8-24	3534-3/8MIP	3534-3/8MIPM	3534-3/8MIPN	3500-MIP2
7/16-14		3532-7/16MIP	3532-7/16MIPM	3532-7/16MIPN	3500-MIP2
	7/16-20	3534-7/16MIP	3534-7/16MIPM	3534-7/16MIPN	3500-MIP2
1/2-13		3532-1/2MIP	3532-1/2MIPM	3532-1/2MIPN	3500-MIP2
	1/2-20	3534-1/2MIP	3534-1/2MIPM	3534-1/2MIPN	3500-MIP2



Front End Assemblies (MIP) include the Mandrel (MIPM), Nozzle (MIPN), spacers to suit 1.0D, 1.5D and 2.0D inserts plus a set of shim washers for fine adjustment of installation depth.

## Pneumatic Wire Thread Installation Tools and Front End Assemblies Overview

Detailed instructions are included with every Pneumatic Tool and Front End Assembly.

You will need

- A front-end assembly appropriate to the Wire Thread Inserts you wish to install and the applicable pneumatic tool.
- An air supply providing air pressure up to 100psi (7 bar) incorporating a filtered and lubricated air regulator. Your air supply should also incorporate an isolating switch to stop the air supply to the tool and connectors/couplings.
- PTFE tape should be wound around the threaded end of the air connector prior to screwing into air tool to ensure a good seal.
- If tool is to be used with a work arm assembly please ensure that the instructions supplied with that equipment are read in conjunction with these instructions.

### Front-end assembly

The front-end assembly is used in conjunction with the pneumatic installation tool to aid the installation of Wire Thread Inserts. The front-end assembly winds a mandrel through the insert (1.0D, 1.5D or 2.0D) and through the pre-winder nozzle. When the insert emerges from the nozzle the diameter has been reduced (pre-wound) to facilitate easy entry into the prepared and threaded hole in the parent material.

The front-end assembly consists of two main components • Nozzle • Mandrel

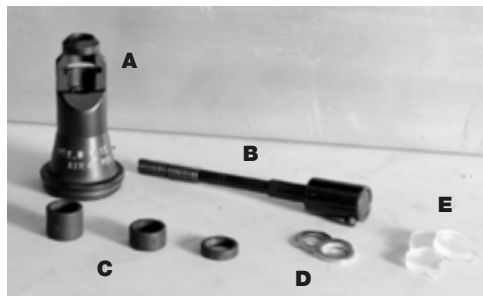

- A Nozzle
- B Mandrel
- C Thickness spacers
- D Shim washers
- E Cushions (for use in the adaptor of an ARO® brand pneumatic tool only)

Three different mandrel types are used depending on the size of the inserts being installed.

Check that the front-end assembly pack also contains 2 or 3 thickness spacers (to suit different length inserts) and at least 3 shim washers. Wire Thread Inserts should be installed 3/4 to 1-1/2 pitches below the surface of a countersunk hole or 1/4 to 1/2 coil below the surface of a flush hole. The Wire Thread Insert must be fully engaged with the thread in the hole throughout its length.

Separate mandrel from nozzle by rotating the mandrel anti-clockwise until the mandrel disengages. You can now assemble the correct combination of spacers and shims (if necessary) between the clutch seat and nozzle.

Identify the length of the insert to be installed and select spacers to adjust insertion depth eg: for 1.0D inserts select the longest spacer - the longer the insert the shorter the required spacer. Once the spacers and shims have been positioned on the shaft of the mandrel lubricate the mandrel thread with light machine oil and wind the mandrel through the nozzle. Locate the mandrel pin in the slot of the driving spline (inside the adaptor case) and slide the front end assembly into the case. Tighten the retaining ring (anti-clockwise) finger tight only - over tightening will restrict free movement of the mandrel, possibly resulting in damage. **The mandrel should always be wound through the nozzle so that the threaded section is fully disengaged prior to assembling the tool.**



Front end assembly with longest spacer to suit 1.0D insert.



Front end assembly with longest spacer to suit 1.0D insert and shim washer.



Finished front end assembly with mandrel wound through the pre-winder nozzle.



Locate mandrel pin in the slot of the driving spline and slide the front end assembly into the case.

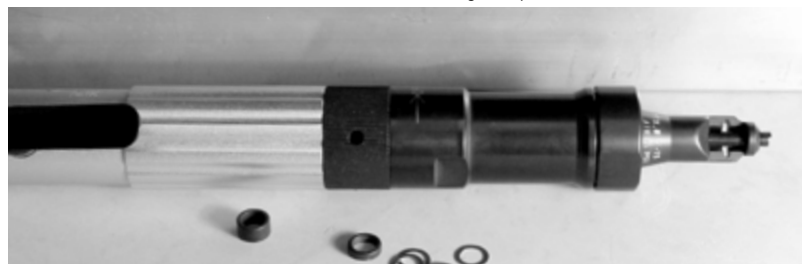

Ensure the front end assembly insert chamber opening is aligned with the trigger of the air motor. Final adjustments may still need to be made (using shim washers) to ensure that the inserts are installed to the optimum depth.

### Recommended air pressures

Insert size – inch	#2	#3	#6	#8	#10	1/4"	5/16"	3/8"	7/16"	1/2"
Insert size – metric	M2.0-2.2	M2.5	M3.0	M3.5	M4.0-4.5	M6.0-7.0	M8.0	M10.0	M11.0	M12.0
Recommended pressure – psi	25	25-30	25-30	40	45	50-60	60	70	70-80	90
Recommended pressure – bar	1.7	1.7-2.0	1.7-2.0	2.8	3.0	3.5-4.1	4.1	4.8	4.8-5.5	6.2

Detailed usage manuals, instructions and exploded diagrams are available for download at [powercoil.com.au](http://powercoil.com.au)

Die aus nicht rostendem Chromnickelstahl hergestellten PowerCoil Gewinde Einsätze (Drahtgewindeeinsätze) sorgen für hochfeste interne Gewinde, die temperatur- und rostbeständig sind. Ihr einzigartiges Design garantiert überlegene Gewinde, deren Verbundfestigkeit durch keine andere Befestigungsmethode erreicht wird. Die Einsätze sind in zwei Grundausführungen – frei laufend oder mit Screwlocking- erhältlich, und sind viel leichter und preiswerter als entsprechende andere Gewindeeinsatztypen. Aufgrund ihrer kompakten Größe können sie normalerweise ohne weitere Vorkehrungen in bestehende Designs integriert werden.

### FREE RUNNING (FREI LAUFEND)

Die aus präzisions-profilierem Austenitdelstahl hergestellten PowerCoil free running inserts (frei laufenden Einsätze) haben eine federartige Erscheinung. Wenn eingebaut – unter Einsatz beliebiger Hand- und automatischer Werkzeuge –, bilden sie stabile, dauerhafte interne Gewinde, die hitze- und rostbeständig sind. Nach dem Einpassen wird ihre Einbaulage durch Radialdruck zwischen den Windungen und den Seiten der Gewindebohrung fixiert. Dieser Druck kommt dadurch zustande, dass der freie Durchmesser der Einsätze um einen festgelegten Betrag größer als der installierte Durchmesser ist.

### SCREW LOCKING (SCREWLOCKEND)

Screwlockende (oder selbstsichernde) Einsätze sind bei Anwendungen, die zyklischen Schwingungen oder Stoßwirkungen ausgesetzt sind, besonders vorteilhaft. Außer den Vorzügen der frei laufenden Einsätze bieten screwlockende Einsätze noch zusätzlich die selbstsichernde Screwlockung. Die Screwlockung wird dabei durch eine oder mehrere polygon geformte Windungen erzielt, die klemmend auf die Flanken der eingedrehten Schraube wirken. Jede dieser Windungen hat eine tangentiell verlaufende Sperrsehne, die in den inneren Durchmesser der normalen, frei laufenden Windungen hineinragt. Wenn das Bolzengewinde durch die Windungen geht, werden die Klemmflächen nach außen verdrängt und üben dann radialen oder Klemmdruck auf das Bolzengewinde aus. Wenn das Bolzengewinde entfernt wird, nehmen die Windungen wieder ihre ursprüngliche Form an und ermöglichen wiederholten Einsatz unter Beibehaltung eines messbaren Klemmdrucks. Hinweis: Es wird empfohlen, beim Einsatz von Schraubverschlusseinsätzen geschmierte oder eng anliegende, überzogene Bolzen oder Schrauben zu verwenden.

### EIGENSCHAFTEN UND VORZÜGE

Jahrelang wurden spiralgewundene Drahtgewindeeinsätze als Reparaturmittel für beschädigte Gewinde beschrieben, und diese speziellen Verbindungen litten somit unter einem falschen Image.

Sie sind viel leichter und preiswerter als vergleichbare Gewindeeinsatztypen, und aufgrund ihrer Kompaktheit können sie normalerweise in existierende Designs integriert werden, auch wenn diese hierzu nicht vorgesehen waren. Im Gegensatz zu anderen Sparmaßnahmen führt ihr Einsatz zu Qualitäts- und Leistungsverbesserung bei gleichzeitiger Reduzierung der Gesamtproduktionskosten. Sie ermöglichen die Verwendung von kleineren Querschnitten oder leichteren Mutterwerkstoffen, ohne dass bei der Festigkeit der Gewinde Kompromisse eingegangen werden müssen. Sie schützen gebohrte Gewinde vor Defekten, die aufgrund von Abriss, Festfressen, Rost und Verschleiß auftreten. PowerCoil Gewinde Einsätze werden aus austenitischem Edlestahl hergestellt, der auf eine Zugfestigkeit von über 200 000psi und eine Härte von Rc43-50 verformungsgehärtet ist. Die Oberflächenbeschaffenheit der Einsätze ist ausgezeichnet, sodass durch Reibung verursachte Gewindekorrosion praktisch ausgeschlossen ist.

Das kontinuierliche Spiraldesign macht dicke Wandstrukturen zur Unterlegung der internen und externen Gewinde unnötig – die Drahtwindung mit rhombischem Profil IST das Gewinde. PowerCoil Gewinde Einsätze können in Naben oder Flanschen mit reduziertem Durchmesser und in engen Bauräumen installiert werden – sie sind Platz sparend und leicht, bei gleichzeitig hoher Festigkeit. Ein Nabendurchmesser, der dem Nenn Durchmesser des Bolzens entspricht, ist normalerweise ausreichend.

Ein vollständiges Sortiment von Einbauwerkzeugen für spezifische Produktionsmethoden ist erhältlich - Handeinbauwerkzeuge für kleine Lose und Reparaturen, sowie elektrische und pneumatische Werkzeuge für Loseproduktionserfordernisse.

### FESTIGKEIT

Aufgrund ihrer Biegsamkeit erzeugen Drahtgewindeeinsätze im Vergleich mit herkömmlichen Gewindebohrungen interne Gewinde mit einer besseren Verteilung der Restanzugslast. Bei herkömmlichen Gewindebohrungen werden 70% der Scherkräfte von den ersten drei Windungen der Bohrung aufgenommen. Die Biegsamkeit der Drahtgewindeeinsätze hilft bei der Kompensation von Flanken- und Steigungswinkel Fehlern, die bei normalen Gewindebohrungen auftreten, und verbessert die Lasttragkraft durch Umwandeln der Restkräfte in eine Ringspannung, die in die Wand der Gewindebohrung abgeleitet wird. Das Design kann somit auf die Festigkeit der Bolzen bauen, auch wenn kleinere und kürzere Gewinde auf Leichtbauwerkstoffen verwendet

werden. Bei der Installation wird der Durchmesser der höher-festen Windungen eines Drahtgewindeeinsatzes reduziert. Die nach außen gerichtete Federspannung klemmt den Einsatz in Position. Jede Windung kann sich unabhängig biegen, um soviel Kontaktfläche wie möglich auf dem Ausgangsgewinde abzudecken. Sowohl statische wie dynamische Lasttragkräften werden hierdurch verbessert.

Standardbolzen

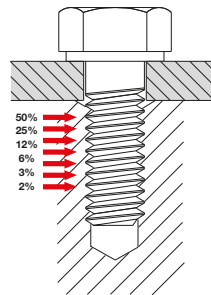

Bolzen mit PowerCoil Einsatz

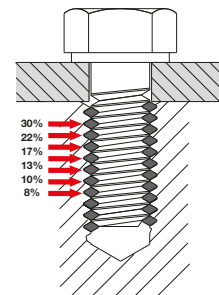

### SPANNUNGSELIMINIERUNG

Das Ausgangsmaterial wird praktisch überhaupt nicht unter Spannung gesetzt, da kein Festmachen, Einrasten, Umformen oder Keilen nötig ist. Der Einsatz wird durch seine nach außen gerichtete Federaktion festgehalten.

### VERSCHLEISSBESTÄNDIGKEIT

Dank der Kombination von Materialhärte und ausgezeichneter Oberflächenqualität der Drahtgewindeeinsätze werden interne Gewinde erzeugt, die den Verschleiß aufgrund von Gewindereibung praktisch ausschließen. Dies ist besonders bei Anwendungen, die wiederholten Ein- und Ausbau erfordern von unschätzbarem Wert. Der niedrige Reibungskoeffizient garantiert, dass praktisch das gesamte Drehmoment in Klemmkraft umgesetzt wird, und die Gewinde fest angezogen bleiben.

### KORROSIONSSCHUTZ

Unter normalen Umgebungsbedingungen ist der in PowerCoil verwendete 18/8 austenitische Edlestahl draht rostbeständig. Das Auftreten galvanischer Vorgänge im Gewinde ist geringfügig, was die Lebensdauer des Befestigungssystems verlängert. Galvanische Korrosion ist die folgenschwerste Korrosionsart bei Einsätzen und Schraubverbindungen. Galvanische Korrosion ist eine Folge des Kontakts unterschiedlicher Metalle miteinander bei Vorhandensein einer elektrolytischen Lösung. Alle Metalle haben verschiedene Grade von "Reaktivität" und "Stabilität" und können in einer galvanischen Serie zunehmender Reaktivität aufgelistet werden. Gold und Platin sind die edelsten Metalle, während Zink und Magnesium am ehesten reagieren. Die am häufigsten vorkommende elektrolytische Lösung ist normales Wasser. Salzwasser ist aufgrund der hohen Konzentration gelöster Salze besonders korrodierend. Galvanische Korrosion kann am besten verhindert werden, indem Metalle ähnlichen Potentials zusammen verwendet werden und die elektrolytische Leitung eliminiert wird. Der reaktive Edlestahl der PowerCoil Gewinde Einsätze wird nicht passiviert, sodass bei deren Einsetzen in Aluminium- oder Magnesium-Mutterwerkstoffen das Risiko der galvanischen Korrosion wesentlich gemindert wird.

Einige zusätzliche Maßnahmen zur Reduzierung galvanischer Korrosion sind:

1. Die Verbindungen von elektrolytischer Lösung fernhalten. Dies kann durch Dichtungen oder Versiegeln erreicht werden.
2. Kadmierte Einsätze vorgeben. Der Kadmiumbelag bietet eine Rostschutzbarriere. Außerdem ist er schmierfähig, was beim Einsatz von Edelstahlschrauben eventuelles Festfressen abstellt.
3. Das Aufbringen korrosionshemmender Pasten oder Verbindungen, wie Zinkchromatgrundierung (MIL-P-8585) und Strontiumchromatgrundierung (MIL-P-23377). Hinweis: Direkt auf die Gewindeeinsätze aufgetragene Pasten können sich zwischen dem Draht und dem Gewinde festsetzen und die korrekte Toleranz beeinträchtigen. Es wird daher empfohlen, die Paste nur auf die Schraube und nicht auf das Gewinde aufzutragen. Wenn Zinkchromatgrundierung für die Gewindebohrung verwendet wird, sollte sie verdünnt und sparsam aufgetragen werden. Der Einsatz muss eingesetzt werden, bevor die Grundierung antrocknet.
4. Auf den Einsätzen ein Trockenschmiermittel vorgeben, z.B. Molybdänsulfid. Dies bildet eine zusätzliche Rostschutzbarriere.
5. Wenn möglich, und vorausgesetzt es beeinträchtigt die fertige Baugruppe nicht, sollte die externe Verbundfläche mit einer geeigneten Farbe gestrichen werden.

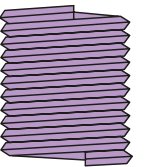
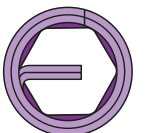
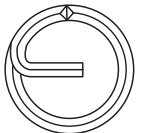
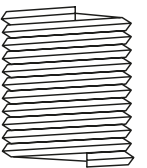
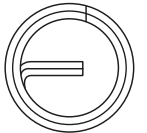

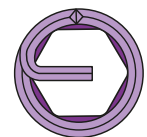
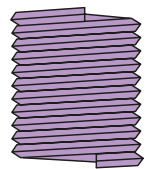
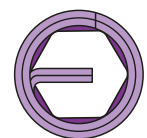
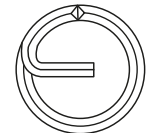
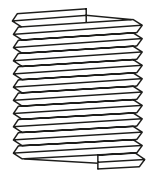
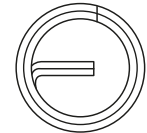

**WERKSTOFFE**

PowerCoil Standard Inserts (Standardeinsätze) sind aus 304 (18/8) austenitischem Edelstahl hergestellt, dessen Qualität gemäß DTD 734A als Flugzeugbauniveau zertifiziert ist. Alternative Werkstoffe sind unter anderem 316 Edelstahl und eine Reihe anwendungsspezifischer Beläge.

**ALTERNATIVE WERKSTOFFE**

**Phosphorbronze**

NE-Kupfer/Zinnlegierung gemäß BS2783 PB 102 EH – ist für den Betrieb im Temperaturbereich -200°C bis +300°C geeignet.

**Inconel X-750**

Hitzebeständige, härtbare Nickelbasislegierung (entsprechend Vorgaben SAE AS 7246, DIN/NF 3018, W.NR 2.4669, UNS N07750). Inconel X-750 ist für den Betrieb im Temperaturbereich -200°C bis +550°C geeignet.

**Nimonic 90**

Hitzebeständige, härtbare Nickelbasislegierung BS2 HR 501 (entsprechend der Vorgaben W.NR 2.4632, UNS N07090). Nimonic 90 ist für den Betrieb im Temperaturbereich -100°C bis +650°C geeignet.

Einsatz-material	Max. Temperatur		Typische Anwendungen	Belag
	Spitze	Dauernd		
Edelstahl 304	425°C	315°C	Meiste allgemeine Anwendungen in allen Werkstoffen	FL, AG, CD
	800°F	600°F		
Edelstahl 316	425°C	315°C	Erhöhte Rostbeständigkeit, für Anwendungen mit Salzwasser	FL, AG, CD
	800°F	600°F		
Phosphorbronze	300°C	235°C	Kupferanteile, nicht magnetisch, Anwendungen mit geringer Durchlässigkeit	AG, CD
	572°F	455°F		
Inconel X-750	650°C	550°C	Raumfahrt, Turbinen, korrosionsfördernde Umgebungen, hohe Temperaturen	AG
	1200°F	1020°F		
Nimonic 90	650°C	550°C	Raumfahrt - und Turbinen -anwendungen	AG
	1200°F	1020°F		

**ALTERNATIVE OBERFLÄCHEN UND BELÄGE**

**Kadmiumbelag**

Galvanisch aufgebracht Kadmium gemäß DTD 904/Def Stan 03-19 (entsprechend Vorgaben FED. QQ-P-416, LN 9368). Der Kadmiumbelag ist eine ausgezeichnete Barriere zwischen unähnlichen Metallen, galvanische Korrosion wird wesentlich reduziert, seine gute Schmiereigenschaften und ausgezeichnete Korrosionsbeständigkeit verhindert Festfressen und Verschleiß zwischen den Gewindeteilen. Kadmiumbelag ist für den Betrieb im Temperaturbereich -200°C bis +235°C geeignet

**Kadmierte Teile dürfen nicht**

- Temperaturen über 235°C (455°F) ausgesetzt werden
- mit Treibstoff oder Öl in Kontakt kommen
- mit Lebensmitteln oder Trinkwasser in Kontakt kommen
- mit Titan Komponenten verwendet werden (direkt oder indirekt). Bei erhöhten Temperaturen kann es zu Brüchigkeit mit nachfolgendem Versagen von Komponenten kommen.
- Kadmium ist hochgiftig – vorsichtig verfrachten, bearbeiten und installieren

**Zinkbelag**

Galvanisch aufgebracht Zink gemäß BS 3382. Galvanisch aufbrachte Zinkbeläge sind die in der Industrie am häufigsten verwendeten galvanisierten Oberflächen. Zink ist für den Betrieb im Temperaturbereich -200°C bis +250°C geeignet.

**Silberbelag**

Galvanisch aufgebracht Silber gemäß DTD 939. Silberbeläge verhindern Festfressen und Verschleiß zwischen den Gewindeteilen in hohen Temperaturen und werden hauptsächlich für Verbindungen in Luftfahrtmotoren verwendet. Silberbelag ist für den Betrieb im Temperaturbereich -200°C bis +650°C geeignet. Drahteinsätze mit Silberbelag können in verschiedene Werkstoffe eingesetzt werden, einschließlich Aluminiumlegierungen, Magnesiumlegierungen, korrosions- und hitzebeständige Werkstoffe, usw.

**Drahteinsätze mit Silberbelag** sollten nicht in Titanlegierungen eingesetzt werden, die eine Betriebstemperatur von 300°C ( 570°F) überschreiten. Spannungskorrosion kann als Folge der Kombination von Silber und Titan im Gehäusematerial auftreten.

**Trockenschmiermittel**

Heißgehärtetes Molybdänsulfid als Trockenschmierbelag gemäß MIL-L-0046010 ist ein Belag mit niedrigem Reibungskoeffizienten und ausgezeichneter Lasttragkraft. Trockenschmiermittel verhindert Festfressen und Verschleiß zwischen den Gewindeteilen und kommt besonders bei Anwendungen mit Gewindeeinsätzen mit Screwlocking zur Wirkung. Trockenschmiermittel ist für den Betrieb im Temperaturbereich -100°C bis +250°C geeignet.

Belag/Oberfläche	Teilnr.-Suffix	Geltende Prozess-Spezifikation
Silberbelag	AG	DTD 939
Kadmiumbelag	CD	QQP-416 oder DEF STD 03-19
Trockenschmiermittel	FL	MIL-L-8937 oder MIL-L-46010
Rote Farbe	-	Zur Kennung auf Screwlockungs-Einsätzen*

\* andere Farben können ebenfalls zu Kennungszwecken verwendet werden

**WAHL DER KORREKTEN EINSATZLÄNGE**

PowerCoil Gewinde Einsätze sind in allen gängigen Gewindearten erhältlich. Es sind fünf Einsatzlängen pro Gewindegröße erhältlich. Die korrekte Einsatzlänge ist wichtig, um die Reißlast des Bolzens an die des Mutterwerkstoffs anzugleichen. Die fünf Einsatzlängen (empfohlene Gewindeaufnahme für den PowerCoil Drahtgewindeinsatz), 1D, 1.5D, 2D, 2.5D und 3D sind in den grauen Spalten in der Tabelle unten zu sehen. Es handelt sich hierbei um berechnete Werte, da die Einsätze im nicht eingesetzten Zustand nicht gemessen werden können. Die Zahlen sind Vielfache der Gewindenenngröße oder –durchmesser des Einsatzes. Die tatsächlichen Einsatzlängen in der eingesetzten Position befinden sich in der Einsatzauswahltablelle. Sie sind dort als tatsächliche eingebaute Länge plus 1/2 Steigung angegeben. Mit der Tabelle unten kann eine Einsatzlänge gewählt werden, die eine Gewindeeinheit erzeugt, die so stabil ist, dass sie den Bolzen zerbricht, bevor das Muttermaterial oder der Einsatz beschädigt werden.

**Empfohlene Einsatznennlängen basierend auf der Scherfestigkeit des Mutterwerkstoffs und der Festigkeit des Bolzenmaterials**

**UNIFIED** (source BS7752 Part 1:1994)

Scherfestigkeit des Muttermaterials (KSI)	Bolzenmaterial – min. Zugfestigkeit vor Bruch (KSI)								
	54	75	96	108	125	132	160	180	220
10	2.0	2.5	3.0	3.0	–	–	–	–	–
15	1.5	1.5	2.0	2.5	2.5	3.0	–	–	–
20	1.0	1.5	1.5	2.0	2.0	2.0	2.5	3.0	3.0
25	1.0	1.0	1.5	1.5	1.5	2.0	2.0	2.5	2.5
30	1.0	1.0	1.0	1.5	1.5	1.5	2.0	2.0	2.5
40	1.0	1.0	1.0	1.0	1.0	1.5	1.5	1.5	2.0
50	1.0	1.0	1.0	1.0	1.0	1.0	1.0	1.5	1.5

BEISPIEL: Wenn die Scherfestigkeit des Mutterwerkstoffs 10KSI beträgt und die Zugfestigkeit des Bolzens 54 KSI, ist die korrekte Einsatzlänge 2,0 Durchmesser (2D).

**METRISCH**

Scherfestigkeit des Muttermaterials (MPa)	Bolzenmaterial – min. Zugfestigkeit vor Bruch (MPa)							
	300	400	500	600	800	1000	1200	1400
70	1.5	2.0	2.5	2.5	–	–	–	–
100	1.0	1.5	1.5	2.0	2.5	3.0	–	–
150	1.0	1.0	1.5	1.5	2.0	2.0	2.5	3.0
200	1.0	1.0	1.0	1.0	1.5	1.5	2.0	2.5
250	1.0	1.0	1.0	1.0	1.0	1.5	1.5	2.0
300	1.0	1.0	1.0	1.0	1.0	1.5	1.5	1.5
350	1.0	1.0	1.0	1.0	1.0	1.0	1.5	1.5

BEISPIEL: Wenn die Scherfestigkeit des Mutterwerkstoffs 150MPa beträgt und die Zugfestigkeit des Bolzens 600MPa, ist die korrekte Einsatzlänge 1,0 Durchmesser (1.5D).

**BOLZEN**

PowerCoil Gewinde Einsätze sind für den Einsatz mit allgemein erhältlichen Standardbolzen und –schrauben entworfen, die keine speziellen Komponenten erfordern.

Der Bolzen muss über die gesamte Einsetzlänge eingreifen, um maximale Festigkeit der Einheit zu erreichen. Um nur teilweises Eingreifen auszuschließen, empfiehlt es sich den Mitnehmerzapfen zu entfernen. Dies garantiert, dass die Klemmwindungen vollständig vom Gewinde des Bolzens aufgenommen werden. Wenn dies aufgrund von Designparametern nicht erfolgt, setzen Sie sich bitte mit PowerCoil in Verbindung.

**HINWEISE:**

1. Die angegebenen Bolzenzugkraftswerte sind Mindestwerte. Bei Wahl der Einsatzlänge, beachten Sie die in der Bolzenzeichnung oder den Beschaffungsangaben zulässigen Höchstwerte für die Zugkraft.
2. Betriebstemperaturen können zu wesentlichen Schwankungen der Werte führen. Kompensation sollte daher möglich sein.
3. Die Scherfestigkeit muss in Betracht gezogen werden, da der Mutterwerkstoff am größeren Durchmesser der gebohrten Gewinde Scherbelastung ausgesetzt ist.

4. Wenn ein Wert zwischen zwei Werten in der Tabelle liegen, verwenden Sie den nächstniedrigeren Scherwert oder den nächsthöheren Zugkraftswert.
5. Um optimale Festigkeit zu erreichen, müssen Bolzen- und Gewindelänge sowie die gesamte gebohrte Gewindetiefe lang genug sein, um das Eingreifen des Gewindes über die gesamte Einsatzlänge zu garantieren.

#### EINSÄTZE MIT SCREWLOCKING (SELBSTSICHERND)

PowerCoil Wire Screw Locking Inserts (screwlockende Einsätze) sind für Anwendungen entworfen, die zyklischen Schwingungen oder Stosswirkungen ausgesetzt sind. Die Einsätze mit Schraubklemmung wirken klemmend auf das eingedrehte Element und verhindern somit, dass dieses sich bei Schwingungen oder Stößen löst. Andere, teurere Klemmmechanismen werden damit überflüssig. Sie eignen sich hervorragend für "Einstellschrauben", indem sie die Bewegung eingedrehter Schrauben unterbinden.

#### FUNKTIONSWEISE DER SCREWLOCKEINSÄTZE

PowerCoil Wire Screw Locking Inserts bieten noch zusätzlich die selbstsichernde Screwlocking. Die Screwlocking wird dabei durch eine oder mehrere polygon geformte Windungen erzielt, die radialen Druck auf die eingedrehte Schraube ausüben. Jede dieser Windungen hat eine tangentiell verlaufende Klemmsehne, die in den inneren Durchmesser der normalen, frei laufenden Windungen hineinragt. Wenn das Bolzengewinde durch die Windungen geht, werden die Klemmflächen nach außen verdrängt und üben dann radialen oder Klemmdruck auf das Bolzengewinde aus. Wenn das Bolzengewinde entfernt wird, nehmen die Windungen wieder ihre ursprüngliche Form an und ermöglichen wiederholten Einsatz unter Beibehaltung eines messbaren Klemmdrucks.

**Bitte beachten Sie:** Es wird empfohlen nur geschmierte oder eng anliegende, überzogene Bolzen oder Schrauben mit PowerCoil Screwlockeinsätzen verwendet werden. Beim Einsatz mit wärmebehandelten, nicht belegten oder Edelstahlbolzen muss ein Mittel, das Festfressen verhindert, wie z.B. Molybdändisulfid verwendet werden, um fressenden Verschleiß weitgehend zu verhindern und optimale Nutzungsdauer zu garantieren. Die Nutzungsdauer kann auch durch Vorgabe von Trockenschmiermitteln und Kadmierung verbessert werden.

#### POSITION DER KLEMMWINDUNGEN

Für Längen von 1D, 1.5D, und 2D: Das Zentrum der Klemmwindung(en) befindet sich 1/2 x Anzahl der freilaufenden Windungen vom Mitnehmerzapfen.

Für Längen von 2.5D und 3D: Die Klemmwindung befindet sich um dieselbe Distanz vom Mitnehmerzapfen wie bei Einsätzen mit 2D Länge.

Screwlockende Einsätze sind rot gefärbt, um sie leichter kenntlich zu machen. Die Farbe ist alkohol-löslich und kann, wenn gewünscht, entfernt werden.

#### POWERCOIL WIRE SCREW LOCKING INSERTS (SCREWLOCKENDE EINSÄTZE) - DREHMOMENTWERTE

##### METRISCH STANDARD

Gewinde mm x mm	Drehmoment	
	Max (Nm)	Min (Nm)
M2.2x0.45	0.14	0.02
M2.5x0.45	0.23	0.05
M3.0x0.50	0.45	0.10
M3.5x0.60	0.68	0.12
M4.0x0.70	0.90	0.15
M5.0x0.80	1.60	0.30
M6.0x1.00	3.00	0.40
M7.0x1.00	4.50	0.60
M8.0x1.25	6.00	0.80
M10.0x1.50	10.50	1.40
M12.0x1.75	15.50	2.10
M14.0x2.00	23.50	3.00
M16.0x2.00	31.50	4.20
M18.0x2.50	42.00	5.50
M20.0x2.50	54.00	7.00
M22.0x2.50	67.50	9.00
M24.0x3.00	80.00	10.50
M27.0x3.00	94.00	12.00
M30.0x3.50	108.00	14.00
M33.0x3.50	122.00	15.50
M36.0x4.00	136.00	17.50
M39.0x4.00	150.00	19.50

##### METRISCH FEIN

Gewinde mm x mm	Drehmoment	
	Max (Nm)	Min (Nm)
M8.0x1.00	6.00	0.80
M10.0x1.00	10.50	1.40
M10.0x1.25	10.50	1.40
M12.0x1.25	15.50	2.10
M12.0x1.50	15.50	2.10
M14.0x1.50	23.50	3.00
M16.0x1.50	31.50	4.20
M18.0x1.50	42.00	5.50
M20.0x1.50	54.00	7.00
M22.0x1.50	67.50	9.00
M18.0x2.00	42.00	5.50
M20.0x2.00	54.00	7.00
M22.0x2.00	67.50	9.00
M24.0x2.00	80.00	10.50
M27.0x2.00	94.00	12.00
M30.0x2.00	108.00	14.00
M33.0x2.00	122.00	15.50
M36.0x2.00	136.00	17.50
M39.0x2.00	150.00	19.50
M36.0x3.00	136.00	17.50
Klemmdrehmomente gemäß MP3329, MP3330, MP3331		

#### ROTE FÄRBUNG

PowerCoil Wire Screw Locking Inserts sind mit organischer roter Farbe gefärbt, um sie leichter kenntlich zu machen. Die Farbe beeinträchtigt den Einbau oder die Leistung des Einsatzes nicht und muss nicht entfernt werden (in den meisten Situationen). In Situationen, wo hohe Reinheit gefordert wird (wie bei der Montage von Präzisionsinstrumenten im Reinraum) kann der Farbelag vor der Installation durch Einweichen der Einsätze in Brennspiritus entfernt werden.

**Hinweis: Es ist wichtig, dass der Bolzen alle Windungen des Einsatzes aufnimmt, um maximale Festigkeit zu erreichen.**

**PowerCoil Wire Screw Locking Inserts können Kundenerfordernissen gemäß entworfen werden. In bestimmten Fällen kann das Klemm-Drehmoment reduziert oder erhöht werden, je nach spezifischer Anwendung. Setzen Sie sich mit Ihrer PowerCoil-Vertretung in Verbindung, um Ihre spezifischen Erfordernisse zu diskutieren.**

**Bitte beachten: Für das Einsetzen von PowerCoil screwlockenden Einsätzen wird ein Vorspannpatronen-Werkzeug benötigt. Andere Installationsoptionen besprechen Sie bitte mit Ihrem PowerCoil-Vertreter.**

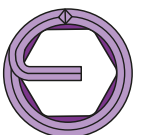
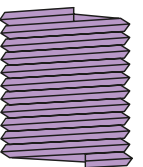
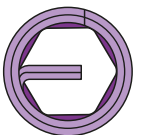
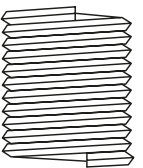
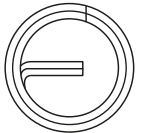

##### UNIFIED NATIONAL STANDARDE – UNC

Gewinde inch x tpi	Drehmoment	
	Max (lb in)	Min (lb in)
2x56	1.25	0.19
3x48	2.00	0.44
4x40	3.00	0.63
5x40	4.69	0.81
6x32	6.00	1.00
8x32	9.00	1.50
10x24	13.00	2.00
12x24	24.00	3.00
1/4x20	30.00	4.50
5/16x18	60.00	7.50
3/8x18	80.00	12.00
7/16x14	100.00	16.50
1/2x13	150.00	24.00
9/16x12	200.00	30.00
5/8x11	300.00	40.00
3/4x10	400.00	60.00
7/8x9	600.00	82.00
1x8	800.00	110.00
11/8x7	900.00	137.00
11/4x7	1000.00	165.00
13/8x6	1150.00	185.00
11/2x6	1350.00	210.00

##### UNIFIED NATIONAL FEIN – UNF

Gewinde inch x tpi	Drehmoment	
	Max (lb in)	Min (lb in)
3x56	0.13	0.44
4x48	0.19	0.63
6x40	6.00	1.00
8x36	9.00	1.50
10x32	13.00	2.00
1/4x28	30.00	3.50
5/16x24	60.00	6.50
3/8x24	80.00	9.50
7/16x20	100.00	14.00
1/2x20	150.00	18.00
9/16x18	200.00	24.00
5/8x18	300.00	32.00
3/4x16	400.00	50.00
7/8x14	600.00	70.00
1x12	800.00	90.00
11/8x12	900.00	117.00
11/4x12	1000.00	143.00
13/8x12	1150.00	165.00
11/2x12	1350.00	190.00
Klemmdrehmomente gemäß NASM8846		

Fabriqués à partir d'acier inoxydable chrome-nickel de qualité, les PowerCoil Wire Thread Inserts [filets rapportés PowerCoil] disposent de filets internes à haute résistance qui résistent aux effets causés par la température et la corrosion. Le design unique garantit des filets supérieurs dont la performance combinée ne peut être atteinte par aucune autre méthode de fixation simple. Disponibles sous deux formes de base, standard ou à frein de vis, ils sont plus légers et moins chers que tout autre type de filet rapporté équivalent et, grâce à leur petite taille, ils peuvent être généralement incorporés aux modèles existants qui ne disposent d'aucune dotation spécifique.

#### MODÈLE STANDARD

Fabriqués à partir de fil d'acier inoxydable austénitique enroulé en spirale hélicoïdale, les PowerCoil free running inserts [filets rapportés PowerCoil standard] ressemblent à des ressorts. Lorsqu'ils sont implantés, à l'aide de l'un des nombreux outils manuels ou automatiques, ils donnent des filets internes solides et permanents qui résistent à la chaleur et à la corrosion. Une fois ajustés, leur position est maintenue par l'action de la pression radiale qui s'exerce entre leurs spires et les flancs du trou taraudé. Cette pression existe parce que leur diamètre réel est plus large d'une valeur calculée que leur diamètre une fois implantés.

#### MODÈLE À FREIN DE VIS

Les filets rapportés à frein de vis (ou à couple permanent) sont extrêmement utiles pour les applications sujettes aux effets provoqués par les vibrations cycliques ou les chocs. En plus des avantages des filets rapportés standard, les PowerCoil screw locking inserts [filets rapportés PowerCoil à frein de vis] offrent une sécurité supplémentaire avec le couple de freinage permanent. Ceci est accompli par la pression radiale exercée sur le filetage extérieur par une ou plusieurs spires à déformation polygonale positionnées sur la longueur du filet rapporté. Chaque spire déformée consiste en un nombre de cordes tangentielles à frein qui dépassent à l'intérieur du diamètre mineur des spires normales. Tandis que le filetage extérieur passe à travers ces spires déformées, les vis à tête plate sont déplacées, exerçant ainsi une pression radiale ou couple permanent sur le filetage extérieur. Lorsque le filetage extérieur est retiré, les spires de freinage débandent pour atteindre leur forme originale, permettant des assemblages répétés tout en conservant un niveau mesurable de couple permanent.

Remarque : il est recommandé que seuls des boulons ou vis lubrifiés ou à tête plate à ajustement serré soient utilisés avec les filets rapportés à frein de vis.

#### CHARACTÉRISTIQUES ET AVANTAGES

Pendant de nombreuses années, les filets rapportés à spires hélicoïdales ont été largement sous-estimés. L'idée qu'ils étaient destinés à la réparation des filets endommagés donna une fausse image à cette pièce de fixation unique.

Ils sont plus légers et moins chers que tout autre filet rapporté équivalent et, grâce à leur petite taille, ils peuvent généralement être introduits dans les modèles existants qui ne disposent d'aucune dotation spécifique. A la différence d'autres mesures économiques, leur introduction augmente la qualité et les performances tout en réduisant les coûts de production. Leur introduction peut aboutir à l'utilisation des sections plus fines ou de matériaux plus légers sans renoncer à la résistance des filets.

Ils protègent les filets taraudés contre le rayage, le grippage, la corrosion et l'usure. Les PowerCoil wire thread inserts [filets rapportés PowerCoil] sont fabriqués à partir de fil en acier inoxydable austénitique qui est durci jusqu'à une charge de rupture supérieure à 200 000 psi et une dureté de Rc43-50. Les filets rapportés bénéficient d'une finition de surface extrêmement lisse qui élimine virtuellement l'érosion du filet causée par le frottement.

Le modèle de spires hélicoïdales continues élimine le besoin d'avoir des structures à paroi épaisses pour soutenir les filets internes et externes : le ressort au profil de diamant EST le filet. Les PowerCoil wire thread inserts [filets rapportés PowerCoil] peuvent être implantés dans des bossages ou des flasques de petite taille et dans des zones comprimées, économisant ainsi de l'espace et du poids tout en fournissant une haute résistance. Un rayon de bossage égal au diamètre nominal du boulon est habituellement suffisant.

Une gamme complète d'outils d'installation est disponible pour s'adapter aux techniques particulières de production. une gamme d'outils manuels existe pour les petits travaux et réparations ; des outils électriques et pneumatiques sont disponibles pour les besoins de production de gros volume.

#### RÉSISTANCE

Grâce à leur flexibilité, les filets rapportés créent des filets internes qui ont une distribution améliorée de la charge de tension résiduelle en comparaison avec les trous taraudés conventionnels où jusqu'à 70% des forces de cisaillement sont soutenues par les trois premiers filets du trou taraudé. La flexibilité des filets rapportés aide à compenser les erreurs d'angle d'hélice et de flanc, inhérentes aux trous taraudés habituels, et améliore nettement la portance en empêchant la création de forces résiduelles dans un effort circonférentiel qui est dispersé dans la paroi du trou taraudé. Ceci permet au modèle de se baser en toute confiance sur

la résistance des boulons en utilisant des filets plus petits et plus courts même lorsqu'il est utilisé avec des matériaux de faible résistance. Les spires à haute résistance d'un filet rapporté subissent une réduction de diamètre pendant l'installation. La force de ressort externe des spires « bloque » le filet rapporté en place. Chaque spire peut se plier indépendamment pour entrer en contact avec la plus grande partie possible de la surface du filet du matériau récepteur. Les capacités de portance statique et dynamique sont améliorées.

#### Boulon standard

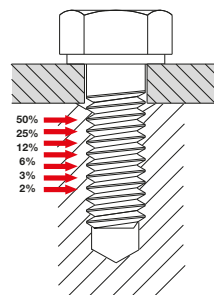

#### Boulon avec PowerCoil insert

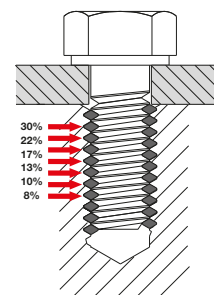

#### ELIMINER LA TENSION

Virtuellement, aucune tension ne s'introduit à l'intérieur du matériau récepteur parce qu'il n'y a pas d'agrafage, de verrouillage, de retainte ou d'accrochage en place. Le « jeu élastique » externe du filet rapporté le tient en place.

#### RÉSISTANCE À L'USURE

La combinaison de la dureté du matériau avec la surface brillante des filets rapportés crée des filets internes dans lesquels l'usure causée par le frottement des filets est virtuellement éliminée. Ceci est particulièrement utile pour les applications qui requièrent des montages et démontages répétés. Le faible coefficient de frottement garantit que l'ensemble du couple d'assemblage appliqué est virtuellement converti en charge de serrage. Donc, cela assure que les filets restent serrés.

#### PROTECTION CONTRE LA CORROSION

Le fil en acier inoxydable austénitique 18/8 utilisé pour les PowerCoil inserts [filets rapportés PowerCoil] résiste à la corrosion dans des conditions environnementales normales. L'action galvanique qui existe à l'intérieur de l'assemblage des filets est réduite, augmentant ainsi la durée de vie de l'assemblage de fixation.

La corrosion galvanique est la forme de corrosion la plus importante qui touche les filets rapportés et les pièces de fixation. La corrosion galvanique apparaît lorsque des métaux distincts sont en contact en présence d'une solution électrolytique. Tous les métaux déploient différents degrés d'« activité » ou de « noblesse » et peuvent être arrangés en une série galvanique d'activité grandissante. L'or et le platine sont les plus nobles tandis que le zinc et le magnésium sont les plus actifs. La solution électrolytique la plus souvent rencontrée est l'eau ordinaire. L'eau de mer ou la vapeur saline provoque bien plus de dégâts à cause des concentrations élevées de sel dissous.

La meilleure façon d'éviter la corrosion galvanique est d'utiliser des métaux potentiels similaires et d'éliminer l'électrolyte. L'acier inoxydable actif des PowerCoil wire thread inserts [filets rapportés PowerCoil] n'est pas passivé. Ceci minimise la possibilité d'apparition de la corrosion galvanique qui apparaît lorsqu'ils sont implantés dans des matériaux récepteurs en aluminium ou magnésium. Les précautions supplémentaires à prendre pour réduire la corrosion galvanique sont :

1. Isoler les pièces de fixation de l'électrolyte. Ceci peut être réalisé à l'aide de joints et de dispositifs d'étanchéité.
2. Stipuler des filets rapportés cadmiés. Le dépôt de cadmium fournit une barrière sacrificielle contre la corrosion. De plus, le dépôt de cadmium a des propriétés lubrifiantes qui minimisent le grippage lorsque des vis en acier inoxydable sont utilisées.
3. Appliquer de la pâte ou un mélange inhibiteur de corrosion sur la vis. Ceux-ci incluent la primaire au chromate de zinc (MIL-P-8585) et la primaire au chromate de strontium (MIL-P-23377). Remarque : la pâte appliquée sur le filet rapporté PowerCoil Thread peut se retrouver enfermée entre le fil et le trou et causer une perte de tolérance appropriée. Il est donc recommandé de n'appliquer la pâte que sur la vis et non sur le filet rapporté. Si une primaire au chromate de zinc est appliquée sur le trou taraudé, elle doit être diluée et appliquée avec parcimonie. Le filet rapporté doit être implanté lorsque la primaire est encore humide.
4. Stipuler l'application d'un film de lubrifiant hydrofuge tel que le bisulfure de molybdène sur les filets rapportés. Celui-ci fournira une seconde barrière pour lutter contre la corrosion.
5. Si cela est possible ou si cela ne perturbe pas l'assemblage terminé, le joint externe doit être revêtu d'une peinture appropriée.



## MATÉRIAUX

Les PowerCoil standard inserts [filets rapportés standard PowerCoil] sont fabriqués à partir d'acier inoxydable austénitique 304 (18/8), pleinement certifié et de qualité pour avions, conformément au DTD 734A. Des matériaux alternatifs sont l'acier inoxydable 316 et une variété de revêtements spécifiques à l'application.

## MATÉRIAUX ALTERNATIFS

### Bronze de phosphore

Un alliage en cuivre / étain non ferreux, conformément au BS2783 PB 102 EH, est approprié pour un fonctionnement à des températures allant de -200°C à +300°C.

### Inconel X-750

Alliage à base de nickel durci par précipitation et résistant aux températures élevées (spécifications équivalentes SAE AS 7246, DIN/AF 3018, W.NR 2.4669, UNS N07750). L'Inconel X-750 est approprié pour le fonctionnement à des températures allant de -200°C à +550° degrés celsius.

### Nimonic 90

Alliage à base de nickel durci par précipitation et résistant aux températures élevées conformément au BS2 HR 501 (spécifications équivalentes W.NR 2.4632, UNS N07090). Le Nimonic 90 est approprié pour le fonctionnement à des températures allant de -100°C à +650° degrés celsius.

Matière du filet	Température max en pointe	Température continue	Applications classiques	Revêtements
Acier inoxydable 304	425°C 800°F	315°C 600°F	La plupart des applications FL, AG, CD générales avec tous les matériaux	FL, AG, CD
Acier inoxydable 316	425°C 800°F	315°C 600°F	Meilleure résistance à la corrosion pour les applications en eau de mer	FL, AG, CD
Bronze de phosphore	300°C 572°F	235°C 455°F	Pièces en cuivre, applications AG, CD non magnétiques et à faible perméabilité	
Inconel X-750	650°C 1200°F	550°C 1020°F	Aéronautique, propulseurs, environnements corrosifs, températures élevées	AG
Nimonic 90	650°C 1200°F	550°C 1020°F	Applications dans l'aéronautique et pour les propulseurs	AG

## APPRÊTS ET REVÊTEMENTS ALTERNATIFS

### Plaque de cadmium

Cadmium déposé par voie galvanique conformément au DTD 904/Def Stan 03-19 (spécifications équivalentes à FED. QQ-P-416, LN 9368). Le plaquage au cadmium fournit une excellente barrière entre les métaux distincts qui réduit de manière dramatique les effets de la corrosion galvanique, sa haute onctuosité et son excellente résistance à la corrosion préviennent les grippages entre les composants filetés. La plaque de cadmium est appropriée pour l'opération à des températures allant de -200°C à +235°C.

### Les pièces plaquées au cadmium de doivent pas

- être soumises à des températures supérieures à 235°C (455°F)
- entrer en contact avec du combustible ou de l'huile chaude
- entrer en contact avec de la nourriture ou de l'eau potable
- être utilisées avec des composants en titane (directement ou indirectement). A des températures élevées, une fragilisation et les dommages qui en résultent peuvent apparaître.
- Le cadmium est hautement toxique ; en conséquence, une attention particulière doit être observée durant le transport, la manipulation et l'installation.

### Plaque de zinc

Zinc déposé par voie galvanique conformément au BS 3382. Le zinc déposé par voie galvanique est l'apprêt le plus largement utilisé dans l'industrie. Le zinc est approprié pour l'opération à des températures allant de -200°C à +250°C.

### Plaque en argent

Argent déposé par voie galvanique conformément au DTD 939. Le plaquage en argent est utilisé afin de prévenir le grippage entre les composants filetés qui peut apparaître lors d'applications à des températures élevées et il est plus largement appliqué aux pièces de fixation des moteurs d'avion. La plaque en argent est appropriée pour l'opération à des températures allant de -200°C à +650°C. Les filets rapportés plaqués à l'argent peuvent être implantés dans divers matériaux comme les alliages d'aluminium, les alliages de magnésium, les matériaux résistants à la corrosion et aux températures élevées, etc.

**Les filets rapportés plaqués à l'argent ne sont pas recommandés** pour l'installation dans des alliages de titane qui pourraient servir à des

températures excédant 300°C ( 570°F). La corrosion sous contrainte, résultat de la combinaison entre l'argent et le titane, peut apparaître dans le matériau des boîtiers.

### Film de lubrifiant hydrofuge

Un revêtement de film solide de lubrifiant hydrofuge de bisulfure de molybdène vulcanisé à chaud, conformément au MIL-L-0046010, fournit un revêtement avec un faible coefficient frictionnel avec d'excellentes capacités de portance. Le film de lubrifiant hydrofuge prévient contre le grippage entre les composants filetés et est particulièrement efficace dans les applications de filets rapportés à frein de vis. Le film de lubrifiant hydrofuge est approprié pour l'opération à des températures allant de -100°C à +250°C.

Plaquage/Apprêt	Suffixe du nr. de pièce	Spécification de procès applicable
Plaque en argent	AG	DTD 939
Plaque de cadmium	CD	QQP-416 ou DEF STD 03-19
Film de lubrifiant hydrofuge	FL	MIL-L-8937 ou MIL-L-46010
Colorant rouge	-	Appliqué pour les filets rapportés à frein à des fins d'identification*

\* des colorants d'une autre couleur peuvent être utilisés à des fins d'identification particulière

## SÉLECTION DE LA LONGUEUR CORRECTE DU FILET RAPPORTÉ

Les PowerCoil wire thread inserts [filets rapportés PowerCoil] sont disponibles pour tous les types de filets classiques. Cinq longueurs de filets rapportés sont disponibles pour chaque taille de filet. Il est important de sélectionner la longueur correcte de filet rapporté afin d'équilibrer la charge de rupture du boulon et la résistance au cisaillement du matériau récepteur. Les cinq longueurs de filet rapporté (prise de filet recommandée pour le PowerCoil wire thread insert [filet rapporté PowerCoil]), 1D, 1.5D, 2D, 2.5D et 3D sont indiquées dans la zone ombragée du tableau ci-dessous. Ce sont des nombres calculés puisque les filets rapportés ne peuvent pas être mesurés à l'état libre (non implantés). Les nombres sont des multiples de la dimension nominale du filet, ou du diamètre, du filet rapporté. Les longueurs actuelles de filet rapporté qui se trouvent dans la position d'installation sont énumérées dans les tableaux de sélection des filets rapportés. Elles représentent la longueur réelle lorsqu'ils ont implantés, plus 1/2 pas. A l'aide du tableau ci-dessous, une longueur de filet rapporté peut être sélectionnée afin de produire un système fileté suffisamment résistant pour fracturer un boulon avant qu'il ne raye ou n'endommage le matériau récepteur ou le filet rapporté.

### Longueurs nominales recommandées de filet rapporté basées sur les forces du matériau récepteur versus celles du matériau du boulon

UNIFIE (source BS7752 Part 1:1994)

Force de cisaillement du matériau récepteur (KSI)	Charge de rupture (KSI) ultime minimale du matériau du boulon									
	54	75	96	108	125	132	160	180	220	220
10	2.0	2.5	3.0	3.0	-	-	-	-	-	-
15	1.5	1.5	2.0	2.5	2.5	3.0	-	-	-	-
20	1.0	1.5	1.5	2.0	2.0	2.0	2.5	3.0	3.0	-
25	1.0	1.0	1.5	1.5	1.5	2.0	2.0	2.5	2.5	-
30	1.0	1.0	1.0	1.5	1.5	1.5	2.0	2.0	2.5	-
40	1.0	1.0	1.0	1.0	1.0	1.5	1.5	1.5	2.0	-
50	1.0	1.0	1.0	1.0	1.0	1.0	1.0	1.0	1.5	1.5

EXEMPLE : Si la force de cisaillement du matériau récepteur est de 10KSI et la charge de rupture du boulon est de 54 KSI, la longueur correcte du filet rapporté est de 2.0 diamètre (2D).

### METRIQUE

Force de cisaillement du matériau récepteur (MPa)	Charge de rupture (Mpa) ultime minimale du matériau du boulon							
	300	400	500	600	800	1000	1200	1400
70	1.5	2.0	2.5	2.5	-	-	-	-
100	1.0	1.5	1.5	2.0	2.5	3.0	-	-
150	1.0	1.0	1.5	1.5	2.0	2.0	2.5	3.0
200	1.0	1.0	1.0	1.0	1.5	1.5	2.0	2.5
250	1.0	1.0	1.0	1.0	1.0	1.5	1.5	2.0
300	1.0	1.0	1.0	1.0	1.0	1.5	1.5	1.5
350	1.0	1.0	1.0	1.0	1.0	1.0	1.5	1.5

EXEMPLE : Si la force de cisaillement du matériau récepteur est de 150Mpa et la charge de rupture du boulon est de 600Mpa, la longueur correcte du filet rapporté est de 1.5 diamètre (1.5D).

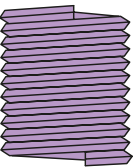
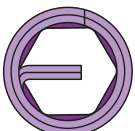
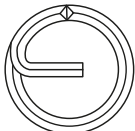
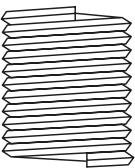
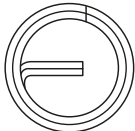
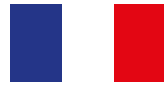

**PRÉVISION DU BOULON**

Les PowerCoil wire thread inserts [filets rapportés PowerCoil] sont conçus pour être utilisés avec des boulons et des vis standard et facilement accessibles qui ne requièrent pas de matériel spécial.

Le boulon doit s'engager sur toute la longueur du filet rapporté pour atteindre la résistance maximale de l'assemblage. Afin d'éviter un engagement partiel, il est recommandé que le tenon soit toujours retiré. Cela garantira également que la (les) spire(s) de freinage sera (seront) engagée(s) par les filets complets du boulon. Si les paramètres de design empêchent ceci, contactez PowerCoil pour demander assistance.

**REMARQUES :**

1. Les charges de rupture du boulon spécifiées sont les charges minimales. Lorsque vous choisissez une longueur de filet rapporté, vous devez prendre en considération la charge de rupture maximale permise par le schéma du boulon ou la spécification d'approvisionnement.
2. Les températures de service peuvent causer des variations significatives des valeurs de la charge, en conséquence une marge doit être permise.
3. L'importance des valeurs de cisaillement ne doit pas être perdue de vue parce que le matériau récepteur est enclin à subir une contrainte de cisaillement à proximité du diamètre majeur des filets taraudés.
4. Lorsque les valeurs des charges se trouvent entre deux valeurs parmi celles qui sont indiquées dans les tableaux, utilisez la valeur inférieure de cisaillement du matériau la plus proche, ou la valeur supérieure de charge de rupture du boulon la plus proche.
5. Pour atteindre la résistance maximale, la longueur du boulon et celle du filet, de même que la profondeur du filet taraudé, doivent être suffisantes pour assurer un engagement complet du filet sur toute la longueur du filet rapporté.

**FILETS RAPPORTÉS À FREIN DE VIS (COUPLE PERMANENT)**

Les Screw Locking PowerCoil wire thread inserts [filets rapportés PowerCoil à frein de vis] sont conçus pour les applications sujettes aux effets causés par les vibrations cycliques ou par les impacts. Le filet rapporté à frein de vis exerce une couple permanent sur les pièces de fixation avec un filet extérieur afin d'éviter le desserrage dû aux vibrations ou aux impacts. Ils éliminent le besoin d'utiliser d'autres mécanismes de fixation moins désirables et plus chers. Ils sont excellents lorsqu'ils sont utilisés dans des applications de « vis de réglage » évitant ainsi le fluage de la pièce de fixation mâle.

**FONCTIONNEMENT DES FILETS RAPPORTÉS À FREIN DE VIS**

Les PowerCoil Screw Locking inserts [filets rapportés PowerCoil à frein de vis] offrent une sécurité supplémentaire avec le couple de freinage permanent. Ceci est accompli par la pression radiale exercée sur le filetage extérieur par une ou plusieurs spires à déformation polygonale positionnées sur la longueur du filet rapporté. Chaque spire déformée consiste en un nombre de cordes tangentielles à frein qui dépassent à

l'intérieur du diamètre mineur des spires normales. Tandis que le filetage extérieur passe à travers ces spires déformées, les vis de freinage à tête plate sont déplacées et exercent une pression radiale (couple permanent) sur le filetage extérieur.

Lorsque le filetage extérieur est retiré, les spires de freinage débandent pour atteindre leur forme originale, permettant des assemblages répétés tout en conservant un niveau mesurable de couple permanent.

Veillez noter :

Il est recommandé d'utiliser uniquement des boulons ou vis lubrifiés ou à tête plate à ajustement serré avec les screw locking PowerCoil wire thread inserts [filets rapportés PowerCoil à frein de vis]. Si des boulons en acier inoxydable ou non métallisés traités thermiquement sont utilisés, un lubrifiant antigrippage, par exemple du bisulfure de molybdène, doit être utilisé afin de minimiser le grippage et assurer une durée de vie maximale. La durée de vie par résistance à l'usure des vis ou des boulons qui utilisent les PowerCoil screw locking wire thread inserts [filets rapportés à frein de vis PowerCoil] peut être augmentée grâce à un lubrifiant hydrofuge ou un plaquage de cadmium.

**EMPLACEMENT DES SPIRES DE FREINAGE**

Pour les longueurs de diamètre 1D, 1.5D et 2D : Le centre de la spire de freinage (ou des spires) est égal à 1/2 du nombre des spires libres. Pour les longueurs de diamètre 2.5D et 3D : La spire de freinage est située à la même distance du tenon que les filets rapportés de longueur 2D.

Les filets rapportés à frein de vis sont colorés en rouge à des fins d'identification uniquement. Le colorant est soluble dans l'alcool et peut être éliminé si nécessaire.

**REVÊTEMENT DE TEINTURE ROUGE**

Les PowerCoil screw locking inserts [filets rapportés PowerCoil à frein de vis] ont généralement un code couleur à l'aide d'un colorant organique à des fins d'identification. Le colorant n'affecte en aucune manière l'installation ou les performances du filet rapporté et il n'est pas nécessaire de l'éliminer (dans la majorité des situations). Dans les situations qui nécessitent une propreté extrême (comme l'assemblage d'instruments de précision dans une pièce propre), le colorant peut être éliminé en immergeant les filets rapportés dans une solution d'alcool dénaturé avant d'être implantés.

**Les PowerCoil screw locking inserts [filets rapportés à frein de vis PowerCoil] peuvent être conçus pour répondre aux besoins particuliers du client. Dans certains cas et applications, le couple permanent peut être affaibli ou renforcé afin répondre aux nécessités d'une application spécifique. Dans ces situations, veuillez contacter votre représentant PowerCoil pour discuter de vos besoins particuliers.**

**Veillez noter : L'installation des PowerCoil screw locking inserts [filets rapportés à frein de vis PowerCoil] exige l'utilisation d'un outil de pré-enroulage. Veuillez discuter d'autres options d'installation avec votre agent PowerCoil.**

**VALEURS DE COUPLE DU POWERCOIL LOCKING INSERT [FILET RAPPORTÉ POWERCOIL]**

METRIQUE A PAS NORMAUX			METRIQUE A PAS FINS			UNIFIED NATIONAL STANDARD - UNC			UNIFIED NATIONAL FEIN - UNF		
Filet mm x mm	Couple Max (Nm)	Couple Min (Nm)	Filet mm x mm	Couple Max (Nm)	Couple Min (Nm)	Filet pouce x tpi	Couple Max (livre par pouce)	Couple Min (livre par pouce)	Filet pouce x tpi	Couple Max (livre par pouce)	Couple Min (livre par pouce)
M2.2x0.45	0.14	0.02	M8.0x1.00	6.00	0.80	2x56	1.25	0.19	3x56	0.13	0.44
M2.5x0.45	0.23	0.05	M10.0x1.00	10.50	1.40	3x48	2.00	0.44	4x48	0.19	0.63
M3.0x0.50	0.45	0.10	M10.0x1.25	10.50	1.40	4x40	3.00	0.63	6x40	6.00	1.00
M3.5x0.60	0.68	0.12	M12.0x1.25	15.50	2.10	5x40	4.69	0.81	8x36	9.00	1.50
M4.0x0.70	0.90	0.15	M12.0x1.50	15.50	2.10	6x32	6.00	1.00	10x32	13.00	2.00
M5.0x0.80	1.60	0.30	M14.0x1.50	23.50	3.00	8x32	9.00	1.50	1/4x28	30.00	3.50
M6.0x1.00	3.00	0.40	M16.0x1.50	31.50	4.20	10x24	13.00	2.00	5/16x24	60.00	6.50
M7.0x1.00	4.50	0.60	M18.0x1.50	42.00	5.50	12x24	24.00	3.00	3/8x24	80.00	9.50
M8.0x1.25	6.00	0.80	M20.0x1.50	54.00	7.00	1/4x20	30.00	4.50	7/16x20	100.00	14.00
M10.0x1.50	10.50	1.40	M22.0x1.50	67.50	9.00	5/16x18	60.00	7.50	1/2x20	150.00	18.00
M12.0x1.75	15.50	2.10	M18.0x2.00	42.00	5.50	3/8x18	80.00	12.00	9/16x18	200.00	24.00
M14.0x2.00	23.50	3.00	M20.0x2.00	54.00	7.00	7/16x14	100.00	16.50	5/8x18	300.00	32.00
M16.0x2.00	31.50	4.20	M22.0x2.00	67.50	9.00	1/2x13	150.00	24.00	3/4x16	400.00	50.00
M18.0x2.50	42.00	5.50	M24.0x2.00	80.00	10.50	9/16x12	200.00	30.00	7/8x14	600.00	70.00
M20.0x2.50	54.00	7.00	M27.0x2.00	94.00	12.00	5/8x11	300.00	40.00	1x12	800.00	90.00
M22.0x2.50	67.50	9.00	M30.0x2.00	108.00	14.00	3/4x10	400.00	60.00	11/8x12	900.00	117.00
M24.0x3.00	80.00	10.50	M33.0x2.00	122.00	15.50	7/8x9	600.00	82.00	11/4x12	1000.00	143.00
M27.0x3.00	94.00	12.00	M36.0x2.00	136.00	17.50	1x8	800.00	110.00	13/8x12	1150.00	165.00
M30.0x3.50	108.00	14.00	M39.0x2.00	150.00	19.50	11/8x7	900.00	137.00	11/2x12	1350.00	190.00
M33.0x3.50	122.00	15.50	M36.0x3.00	136.00	17.50	11/4x7	1000.00	165.00			
M36.0x4.00	136.00	17.50	Valeurs du couple de freinage en conformité avec MP3329, MP3330, MP3331			13/8x6	1150.00	185.00			
M39.0x4.00	150.00	19.50				11/2x6	1350.00	210.00			

Valeurs du couple de freinage en conformité avec NASM8846

**Fabricados en acero inoxidable al cromo níquel de alta calidad, los insertos para reparación de roscas Power Coil proporcionan alta resistencia a las roscas internas lo que da como resultado una alta resistencia a la temperatura y a la corrosión. Su diseño único asegura roscas superiores cuyo comportamiento no puede ser igualado por ningún otro método de seguridad. Se encuentran disponibles en dos presentaciones básicas, standard y de seguridad, son mucho más ligeros y menos costosos que cualquier otro tipo de inserto equivalente y dado su tamaño compacto pueden generalmente incorporarse a diseños existentes en donde no se haya hecho preparación previa.**

#### INSERTOS STANDARD

Fabricados a partir de un alambre de acero inoxidable austenítico, perfilado de precisión austenítico en forma de espiral helicoidal, los insertos standard Power Coil tienen forma de muelle. Cuando se instalan utilizando cualquiera de las herramientas, ya sean manuales o automáticas, proporcionan roscas internas resistentes y permanentes que soportan el calor y la corrosión. Una vez instaladas su posición se mantiene por la acción de presión radial entre las roscas y las ranuras del agujero roscado. Esta presión existe porque su diámetro libre es ligeramente superior al instalado en una pequeña proporción previamente calculada.

#### INSERTOS DE SEGURIDAD

El inserto de seguridad (o de cierre efectivo) están especialmente indicados en aplicaciones sujetas a efectos de vibración cíclica o impactos. Además de las ventajas proporcionadas por los insertos standard, los insertos de seguridad Power Coil ofrecen una seguridad adicional por su auto freno interno que lo hace más efectivo. Esto se consigue gracias a la acción de uno o varios cierres poligonales de las roscas del inserto posicionados a lo largo del mismo, que ejercen presión radial en los flancos de la rosca. En cada vuelta de agarre la rosca de seguridad consta de un número tangencial de roscas que empujan dentro del diámetro menor de la rosca standard. En la medida en que la rosca pasa a través de estas roscas de seguridad, los dispositivos se expanden aplicando presión radial o freno efectivo en la rosca del tornillo. Al retirar el tornillo roscado, las roscas de seguridad relajan su expansión a su forma original permitiendo repetir el roscado del tornillo y manteniendo su nivel de presión radial de seguridad.

Nota, se recomienda que solamente se utilicen tornillos niquelados o bien lubricados, con los insertos de seguridad.

#### CARACTERISTICAS Y BENEFICIOS

Durante muchos años, los insertos helicoidales han sido subestimados. El concepto popular de ser diseñados para reparar roscas dañadas ha dado a éste sistema único, esta falsa imagen.

Son mucho más ligeros y menos costosos que cualquier otro tipo equivalente de inserto

de rosca, y por su tamaño compacto, pueden generalmente introducirse en diseños preexistentes en donde no exista una preparación previa. Además de otros beneficios económicos, su utilización incrementa la calidad y rendimiento mientras reduce el costo total del producto. Su utilización es efectiva al utilizar materiales más delgados o más ligeros sin sacrificar la dureza de la rosca.

Los insertos protegen las roscas originales contra posibles fallos de pérdida de hilos, pérdida de medida, corrosión o desgaste. Los insertos Power Coil están fabricados con cable de acero inoxidable austenítico, que le permite trabajar con una fuerza a la tensión de 200,000 psi y una dureza de RC 43-50. Los insertos tienen un acabado superficial tan fino que prácticamente elimina la fricción que induce al posible desgaste.

El diseño helicoidal no requiere de paredes gruesas para soportar las roscas internas y externas y la rosca esta perfilada con diamante. Los insertos Power Coil pueden instalarse en secciones reducidas de bordes, flancos y dentro de áreas pequeñas – salvando espacio y peso mientras proporcionan alta resistencia.

El radio de una superficie que es igual al diámetro nominal del tornillo es normalmente suficiente.

Una amplia gama de herramientas de instalación se encuentra disponible para adaptarse a diferentes técnicas de producción. Existe una gama de herramientas manuales para pequeñas reparaciones; y las herramientas eléctricas y neumáticas están disponibles para altas producciones generalmente.

#### RESISTENCIA

Debido a su flexibilidad, los insertos conforman roscas internas que cuentan con una mucho mejor distribución de carga residuales comparados con agujeros roscados convencionales, en donde un porcentaje superior al 70% de las fuerzas cortantes son llevadas a cabo por las tres primeras roscas en el agujero roscado. La flexibilidad de los insertos ayudan a compensar los errores del paso y del ángulo de flancos inherentes a los agujeros normales roscados, y mejora significativamente la capacidad de carga por deflexión de fuerzas residuales dentro de la rosca en donde la presión se dispersa hacia las paredes del agujero roscado. Esto hace que el diseño sea muy fiable y de gran resistencia utilizando roscas mas pequeñas y mas cortas aun cuando los insertos sean usados en materiales menos resistentes.

Los insertos Power Coil de alta flexibilidad reducen su diámetro durante la instalación.

La fuerza del inserto al expandirse en el agujero asegura el inserto en su lugar correcto. Cada filete puede flexionarse independientemente para ponerse en contacto con la mayor cantidad de material de la superficie de la rosca. Ambas capacidades de carga, estática y dinámica son mejoradas.

Tornillo Standard

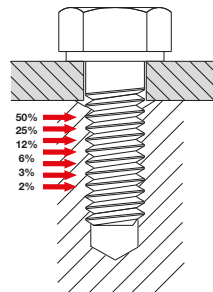

Tornillo Con Inserto PowerCoil

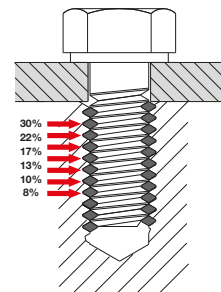

#### ELIMINA TENSIONES

Virtualmente ninguna tensión es introducida al material porque no hay sistema de sujeción, amarre, bloqueo, etc., en el lugar, sino que la acción de muelle del inserto lo mantiene en su lugar.

#### RESISTENCIA AL DESCASTE

La combinación de la dureza en el material y el acabado brillante de los insertos configuran roscas internas, en las que el desgaste de la rosca ocasionada por el uso es prácticamente eliminada. Esto es de gran valor para aplicaciones que requieren ensamblaje y desensamblaje repetido. El bajo coeficiente de fricción asegura prácticamente que todas las fuerzas de ensamblaje aplicadas se conviertan en cargas de sujeción, dando como resultado que las roscas se mantengan firmes.

#### PROTECCION CONTRA CORROSION

El alambre de acero inoxidable austenítico 8/18 usado en los insertos Power Coil resisten la corrosión bajo condiciones ambientales normales. La acción galvánica dentro del ensamblaje de la rosca se reduce, incrementando la vida del ensamblaje y del tornillo.

La corrosión galvánica es la forma más significativa de corrosión y afecta a los insertos y a los tornillos. La corrosión galvánica aparece cuando metales distintos están en contacto en la presencia de una solución electrolítica. Todos los metales tienen grados diferentes de "actividad" o "nobleza" y pueden arreglarse en series galvánicas de actividad incrementada. El oro y el platino son los más nobles, mientras el zinc y el magnesio son los más activos. La solución electrolítica más común encontrada es agua ordinaria. El agua de mar o spray salado es más dañina por la alta concentración de sales disueltas.

La mejor manera de prevenir la corrosión galvánica es usar metales potencialmente similares y eliminar el conductor electrolítico. El activo del acero inoxidable usado en las roscas de los insertos Power Coil no está pasivado. Esto minimiza la posibilidad de que ocurra corrosión galvánica cuando se instalan en aluminio y magnesio o materiales similares. Algunas precauciones adicionales que deben tomarse en cuenta para prevenir la corrosión galvánica son:

1. Aislar los tornillos de los electrolitos. Esto puede hacerse a través de encapsulado o sellado.
2. Específicamente usar insertos recubiertos de cadmio. El acabado en cadmio proporciona una barrera contra la corrosión. Adicionalmente, el acabado en cadmio tiene propiedades lubricantes que minimizan el roce cuando se usan tornillos de acero inoxidable.
3. Aplicar pastas o compuestos inhibidores de corrosión al tornillo. Esto incluye al sellador zinc cromado (MIL-P-8585) y el sellador estroncio cromado (MIL-P-23377). Nota: Las pastas aplicadas al inserto helicoidal entre las roscas y el agujero pueden causar pérdida de la tolerancia propia. Por lo tanto se recomienda aplicar la pasta solamente al tornillo y no al inserto. Si el sellador cromo zinc es aplicado al agujero roscado debe rebajarse y aplicarse escasamente. El inserto debe instalarse mientras el sellador esta aun húmedo.
4. Dar una película de lubricante seco como el disulfato de molibdeno en los insertos, proporciona una barrera secundaria contra la corrosión.
5. Cuando sea práctico o cuando no interfiera con el ensamblaje, la junta externa deberá ser cubierta con una pintura adecuada.

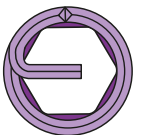
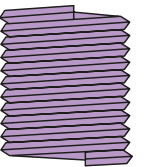
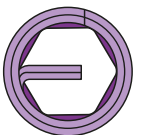
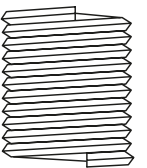
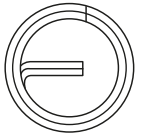

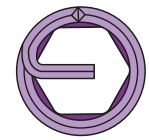
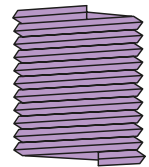
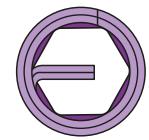
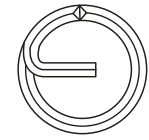
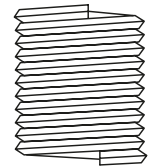
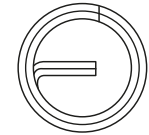

**MATERIALES**

Los insertos standard Power Coil están fabricados en acero inoxidable austenítico 304 (18/8) y ampliamente certificados como calidad aeroespacial de conformidad con la DTD 734 A. Los materiales alternativos incluyen aceros inoxidables 316 y una variedad de aplicaciones específicas para superficies recubiertas.

**MATERIALES ALTERNATIVOS**

**Fósforo Bronce**

Aleación no ferrosa de cobre estaño de acuerdo a BS2783 PB 102 E4 – es adecuada para trabajar a temperaturas entre -200° C a + 300° C

**Inconel X-750**

La aleación base níquel resistente a temperaturas de temple (especificaciones equivalentes SAE AS 7246, DIN/NF3018 W.NR 2.4669, UNS N07750). El Inconel X-750 se recomienda para el rango de temperaturas de -200° C a +550° C.

**Nimonic 90**

La aleación base níquel resistente a temperatura de temple de conformidad con BS2 HR 501 (especificaciones equivalentes W.NR 2.4632, UNS N07090). El Nimonic 90 es recomendable para trabajar a temperaturas entre -100° C a +650° C.

Material del Inserto	Temperatura Máxima		Aplicaciones típicas	Recubrimientos
	Pico	Continua		
Acero 304	425°C 800°F	315°C 600°F	Aplicaciones generales Para todos los materiales	FL, AG, CD
Acero 316	425°C 800°F	315°C 600°F	Incrementa la resistencia a la corrosión, para aplicaciones en agua salada	FL, AG, CD
Fósforo Bronce	300°C 572°F	235°C 455°F	Material de cobre, no magnético, aplicaciones de baja permeabilidad	AG, CD
Inconel X-750	650°C 1200°F	550°C 1020°F	Aeroespacial, turbinas ambientes corrosivos, Uso en altas temperaturas	AG
Nimonic 90	650°C 1200°F	550°C 1020°F	Aeroespacial y aplicaciones en turbinas	AG

**ALTERNATIVAS DE TERMINADO Y RECUBRIMIENTO**

**Terminado Cadmio**

Cadmio electro depositado de conformidad con DTD905/Def. Stan 03-19 especificaciones equivalentes FED, QQ-P416, LN 9368) El terminado cadmio proporciona una excelente barrera entre metales diferentes reduciendo dramáticamente los efectos de la corrosión galvánica, su alta lubricidad y excelente resistencia a la corrosión previene el roce y la sobremedida entre los componentes de la rosca. El terminado cadmio esta recomendado para trabajar en el rango de temperatura de -200° C a +235° C.

**Las partes terminadas en Cadmio no deben**

- Someterse a temperaturas por encima de 235°C (455°F)
- Ponerse en contacto con combustible o aceite caliente
- Ponerse en contacto con comida o agua potable.
- Ser usados con componentes de titanio (ya sea directa o indirectamente). A temperaturas elevadas pueden ocurrir resquebrajamiento y fallos en los componentes.
- El cadmio es altamente tóxico - consecuentemente deben tomarse cuidadosas precauciones cuando se embarca, se maneja y se instala.

**Terminado Zinc**

El zinc es depositado electrolíticamente de conformidad con BS3382. El zinc electro depositado es el terminado mas aplicado en la industria. El zinc esta recomendado para trabajar en el rango de temperaturas de -200° C a + 250° C.

**Terminado Plata**

La plata es depositada electrolíticamente de conformidad con DTD939. El terminado plata es usado para prevenir que haya roces o sobremedida entre los componentes de la rosca cuando se usa a altas temperaturas y es el más comúnmente usado en los tornillos para motores de aviación. El terminado plata esta recomendado para trabajar a temperaturas en el rango de -200° C a +650° C. Los insertos terminados en plata pueden ser utilizados con varios materiales incluyendo aleaciones de aluminio, aleaciones de magnesio, materiales resistentes al calor y a la corrosión, etc.

**Los insertos terminados en plata no son recomendados** para instalación en aleaciones de titanio que puedan exceder temperaturas de 300° C (570° F) Alta corrosión como resultado de la combinación de plata y titanio puede ocurrir en el alojamiento.

**Película Lubricante seca**

Sólida película de resistencia al calor bisulfuro de molibdeno, recubierto con una película lubricante seca de conformidad con MIL-L-0046010 provee un recubrimiento con bajo coeficiente de fricción con excelente capacidad de soporte de carga. La película lubricante seca previene el roce y las sobremedidas entre los componentes roscados y es particularmente efectivo en la aplicación de los insertos de seguridad. La película seca lubricante es recomendada para la operación en el rango de temperatura de -100° C a +250° C.

Terminado	Sufijo de No. De parte	Especificaciones a procesos aplicables
Recubrimiento plata	AG	DTD 939
terminado de cadmio	CD	QQP-416 ou DEF STD 03-19
película lubricante seca	FL	MIL-L-8937 ou MIL-L-46010
tintado rojo	-	aplicado a insertos de seguridad para efectos de identificación*

\* Otros colores de tintado pueden utilizarse para efectos de identificación específica.

**SELECCIÓN DE LA CORRECTA LONGITUD DEL INSERTO**

Los insertos de rosca PowerCoil están disponibles en todos los tipos de rosca comunes. Hay cinco longitudes disponibles para cada medida. Es muy importante seleccionar la longitud correcta del inserto con efecto de equilibrar la dureza del material del tornillo con la dureza del material de alojamiento. Las cinco longitudes de insertos (Las recomendaciones de las roscas Power Coil), 1D, 1.5D, 2D, 2.5D y 3D se muestran en el área sombreada en la tabla de abajo.

Los números son calculados ya que los insertos no pueden medirse en estado libre (no instalado). Los números son múltiplos del tamaño de rosca nominal, o diámetro del inserto. Las longitudes actuales del inserto en posición instalada están listadas en las tablas de selección de insertos. Ahí se representa la longitud actual instalada más medio (1/2) paso. Usando la tabla siguiente la longitud de un inserto puede seleccionarse para conseguir un sistema suficientemente resistente para romper un tornillo antes de dañar el inserto o el material de alojamiento.

**Longitud nominal recomendada de insertos basada en material de alojamiento vs. longitud de tornillo**

**UNIFICADO** (fuente BS7752 Part 1:1994)

Resistencia en materiales de alojamiento (KSI)	Material del tornillo fuerza de tensión (KSI)									
	54	75	96	108	125	132	160	180	220	
10	2.0	2.5	3.0	3.0	-	-	-	-	-	
15	1.5	1.5	2.0	2.5	2.5	3.0	-	-	-	
20	1.0	1.5	1.5	2.0	2.0	2.0	2.5	3.0	3.0	
25	1.0	1.0	1.5	1.5	1.5	2.0	2.0	2.5	2.5	
30	1.0	1.0	1.0	1.5	1.5	1.5	2.0	2.0	2.5	
40	1.0	1.0	1.0	1.0	1.0	1.5	1.5	1.5	2.0	
50	1.0	1.0	1.0	1.0	1.0	1.0	1.0	1.5	1.5	

EJEMPLO: Si el material de alojamiento es 10KS1 y la tensión del tornillo es 54KSI, la longitud correcta del inserto es 2.0 de diámetro (2D).

**METRICO**

Resistencia en materiales de alojamiento (MPa)	Material del tornillo fuerza de tensión (MPa)							
	300	400	500	600	800	1000	1200	1400
70	1.5	2.0	2.5	2.5	-	-	-	-
100	1.0	1.5	1.5	2.0	2.5	3.0	-	-
150	1.0	1.0	1.5	1.5	2.0	2.0	2.5	3.0
200	1.0	1.0	1.0	1.0	1.5	1.5	2.0	2.5
250	1.0	1.0	1.0	1.0	1.0	1.5	1.5	2.0
300	1.0	1.0	1.0	1.0	1.0	1.5	1.5	1.5
350	1.0	1.0	1.0	1.0	1.0	1.0	1.5	1.5

EJEMPLO: Si el material de alojamiento es 150 Mpa y la tensión de la tuerca es 500Mpa, la longitud correcta del inserto es de 1.5 de diámetro (1.5 D)

**PROYECCION DEL TORNILLO**

Los insertos Power Coil están diseñados para ser usados con tornillos Standard, normales disponibles que no requieran de especificaciones especiales.

La tuerca debe engranar a lo largo de todo el inserto para asegurar la máxima firmeza del ensamblaje. Para asegurarnos contra engranajes parciales, se recomienda cortar siempre el arrastre del inserto. Esto también garantizará que las roscas de seguridad engranen en todas las roscas del tornillo. Si necesitan ver el diseño de cómo se hace, favor de contactar a Power Coil para asistencia.

**NOTAS:**

1. Se especifican las resistencias mínimas de los tornillos. Cuando se escoge una longitud de inserto, se debe poner atención a la resistencia máxima permitida por el tornillo o sus especificaciones.
2. La temperatura puede provocar variaciones significativas en los valores de resistencia, por lo tanto se debe permitir la compensación.
3. La importancia de los valores de corte deben tenerse en cuenta dado que el material de alojamiento esta sujeto a la presión de corte en la mayor parte del diámetro del agujero roscado.
4. Cuando los valores de resistencia caen entre dos valores en las tablas, se debe optar por el material hacia abajo del valor de corte, o el siguiente valor mas alto de resistencia a la tensión del tornillo.
5. Para asegurar la máxima resistencia, la longitud del tornillo y de la rosca, así como la profundidad del agujero roscado deben ser suficientes para asegurar el total engranaje de todos los filetes a largo de todo el inserto

**INSERTOS PARA TORNILLOS DE SEGURIDAD (TORQUE COMUN)**

Los insertos de seguridad Power Coil están diseñados para aplicaciones sujetas a los efectos de impacto y vibración cíclica. Los insertos de seguridad ejercen una fuerza de cierre en las rosca de los tornillos para prevenir su pérdida debido a vibración o impacto. Eliminan la necesidad de otras opciones, menos deseables y mas costosas de mecanismos de seguridad. Son excelentes en el "ajuste del tornillo" previniendo que el tornillo se desplace de su lugar.

**COMO FUNCIONAN LOS INSERTOS DE SEGURIDAD**

Los insertos de seguridad Power Coil ofrecen una seguridad adicional de cierre al inserto Standard. Esto se consigue gracias a la acción de uno o varios cierres poligonales de las roscas del inserto posicionados a lo largo del mismo, que ejercen presión radial en los flancos de la rosca. En cada vuelta de agarre la rosca de seguridad consta de un número tangencial de roscas que empujan dentro del diámetro menor de la rosca standard.

En la medida en que la rosca pasa a través de estas roscas de seguridad, los dispositivos se expanden aplicando presión radial o freno efectivo en la rosca del tornillo. Al retirar el tornillo roscado, las roscas de seguridad relajan su expansión a su forma original permitiendo repetir el roscado del tornillo y manteniendo su nivel de presión radial de seguridad.

**Nota:**

Con los insertos de seguridad Power Coil, se recomienda utilizar solamente tornillos cerrados recubiertos o tornillos lubricados. Cuando se utilicen tornillos no recubiertos o de acero inoxidable, debe utilizarse un compuesto anti-agarre, como por ejemplo, molibdeno disulfuro, que deberá utilizarse para reducir el roce y asegurar el ciclo máximo de vida. La vida de uso de un tornillo o perno usando los insertos de seguridad Power Coil también puede mejorarse al aplicarse una película lubricante seca o terminado en Cadmio.

**UBICACION DE LAS ROSCAS DE SEGURIDAD**

Para 1D, 1.5D y 2D veces la longitud del diámetro: El centro del inserto de seguridad debe ser igual a la mitad del inserto standard. Para las longitudes de 2.5 D y 3D del diámetro: El inserto de seguridad deberá situarse a la misma distancia del arrastre que los insertos Standard de 2D de longitud.

Los insertos de seguridad están marcados con rojo para su fácil identificación exclusivamente. Este color es soluble en alcohol y puede quitarse, si se desea.

**RECUBRIMIENTO EN ROJO**

Los insertos de seguridad Power Coil están generalmente coloreados con una pintura orgánica roja para efectos de identificación. El color no afecta la instalación o el trabajo del inserto y no requiere ser removido (en la mayoría de los casos). En casos en que se requiere extrema claridad (tales como instrumentos de ensamblajes de precisión en condiciones de limpieza) la pintura puede ser removida, remojando los insertos en una solución de alcohol desnaturalizado antes de su instalación.

**Nota: También es esencial que el tornillo engrane perfectamente en todas las roscas del inserto para mayor resistencia.**

**Los insertos de seguridad PowerCoil pueden ser diseñados de conformidad con las necesidades específicas de un cliente.**

**En algunos casos y aplicaciones el apriete común puede ser disminuido o incrementado para una aplicación específica. En estos casos, favor de contactar a su representante PowerCoil para discutir sus necesidades específicas.**

**Nota. La instalación de los insertos de seguridad PowerCoil requiere del uso de una herramienta pre-rosca especial. Favor de comentar otras opciones de instalación con su agente PowerCoil.**

**VALORES DE APRIETE DE LOS INSERTOS DE SEGURIDAD POWERCOIL**

**METRICO GRUESO**

Rosca	Máximo	Mínimo
mm x mm	Max (Nm)	Min (Nm)
M2.2x0.45	0.14	0.02
M2.5x0.45	0.23	0.05
M3.0x0.50	0.45	0.10
M3.5x0.60	0.68	0.12
M4.0x0.70	0.90	0.15
M5.0x0.80	1.60	0.30
M6.0x1.00	3.00	0.40
M7.0x1.00	4.50	0.60
M8.0x1.25	6.00	0.80
M10.0x1.50	10.50	1.40
M12.0x1.75	15.50	2.10
M14.0x2.00	23.50	3.00
M16.0x2.00	31.50	4.20
M18.0x2.50	42.00	5.50
M20.0x2.50	54.00	7.00
M22.0x2.50	67.50	9.00
M24.0x3.00	80.00	10.50
M27.0x3.00	94.00	12.00
M30.0x3.50	108.00	14.00
M33.0x3.50	122.00	15.50
M36.0x4.00	136.00	17.50
M39.0x4.00	150.00	19.50

**METRICO FINO**

Rosca	Máximo	Mínimo
mm x mm	Max (Nm)	Min (Nm)
M8.0x1.00	6.00	0.80
M10.0x1.00	10.50	1.40
M10.0x1.25	10.50	1.40
M12.0x1.25	15.50	2.10
M12.0x1.50	15.50	2.10
M14.0x1.50	23.50	3.00
M16.0x1.50	31.50	4.20
M18.0x1.50	42.00	5.50
M20.0x1.50	54.00	7.00
M22.0x1.50	67.50	9.00
M18.0x2.00	42.00	5.50
M20.0x2.00	54.00	7.00
M22.0x2.00	67.50	9.00
M24.0x2.00	80.00	10.50
M27.0x2.00	94.00	12.00
M30.0x2.00	108.00	14.00
M33.0x2.00	122.00	15.50
M36.0x2.00	136.00	17.50
M39.0x2.00	150.00	19.50
M36.0x3.00	136.00	17.50

Los valores de apriete siguen la norma MP3329, MP3330, MP3331

**PASO GRUESO AMERICANO UNC**

Rosca	Máximo	Mínimo
inch x tpi	Max (lb in)	Min (lb in)
2x56	1.25	0.19
3x48	2.00	0.44
4x40	3.00	0.63
5x40	4.69	0.81
6x32	6.00	1.00
8x32	9.00	1.50
10x24	13.00	2.00
12x24	24.00	3.00
1/4x20	30.00	4.50
5/16x18	60.00	7.50
3/8x18	80.00	12.00
7/16x14	100.00	16.50
1/2x13	150.00	24.00
9/16x12	200.00	30.00
5/8x11	300.00	40.00
3/4x10	400.00	60.00
7/8x9	600.00	82.00
1x8	800.00	110.00
11/8x7	900.00	137.00
11/4x7	1000.00	165.00
13/8x6	1150.00	185.00
11/2x6	1350.00	210.00

**PASO FINO AMERICANO UNF**

Rosca	Máximo	Mínimo
inch x tpi	Max (lb in)	Min (lb in)
3x56	0.13	0.44
4x48	0.19	0.63
6x40	6.00	1.00
8x36	9.00	1.50
10x32	13.00	2.00
1/4x28	30.00	3.50
5/16x24	60.00	6.50
3/8x24	80.00	9.50
7/16x20	100.00	14.00
1/2x20	150.00	18.00
9/16x18	200.00	24.00
5/8x18	300.00	32.00
3/4x16	400.00	50.00
7/8x14	600.00	70.00
1x12	800.00	90.00
11/8x12	900.00	117.00
11/4x12	1000.00	143.00
13/8x12	1150.00	165.00
11/2x12	1350.00	190.00

Los valores de apriete siguen la norma NASM8846

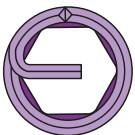
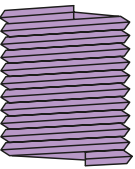
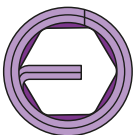
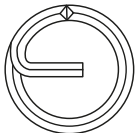
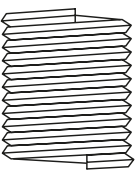
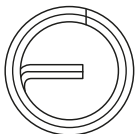

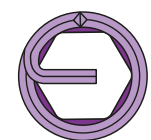
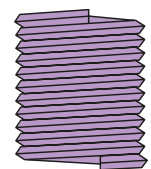
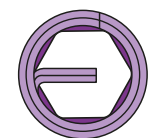
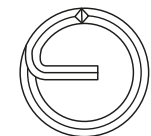
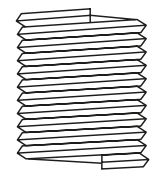
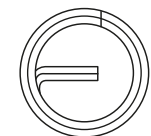

由高质量的铬镍不锈钢制造，PowerCoil螺套可以提供高强度的耐高温耐腐蚀的内螺纹。他们独特的设计确保复合性能的螺套不会被其他简单的紧固方式所替代。他们有着两种类型：普通型的螺套及锁紧型的螺套，这两种类别的螺套与其它相似的螺纹护套相比，不仅更轻更加经济，而且由于其紧凑的结构，使得他们很轻易的可以嵌入已存在的设计作品中而不需预留位置。

#### 普通型螺套

PowerCoil普通型螺套由奥氏体不锈钢旋绕而成，就像所看见的一样为螺旋状。使用手动或者自动工具都可以安装，形成一个坚固的耐高温耐腐蚀的内螺纹。一旦安装完成，他们的位置就会在螺纹孔侧面和自身的螺旋张力的作用下保持不变。这种张力的存在是由于螺套的自由直径要大于安装直径。

#### 锁紧型螺套

锁紧型螺套是一种特殊应用的螺套，多用于震动与碰撞的场合。除了先前提到的普通型螺套的一些优点之外，自锁型的螺套还有着特殊的扭力作用。这种扭力的获得是由于位于螺套中有着一个多边形的自锁螺纹，而恰恰是这个螺纹对外螺纹起着扭力的作用。自锁型螺套有着一圈切线锁弦，可以很容易的看见其内径比普通螺套的直径要小一些。当螺栓通过这个锁弦时，锁弦将给予轴向压力，提供一种扭矩于螺栓上。当旋下螺栓的时候，具有恢复能力的自锁螺套可以多次拆装而不降低螺纹的扭矩。

注意：在使用自锁型螺套的时候，最好能够使用电镀过或者润滑过的螺栓。

#### 特征与利益

多年来，螺纹的护套的使用范围被大大的低估了。大多数情况下，人们都认为螺套这个独特的紧固件的主要作用就是去修复那些被损坏的螺纹。

他们的价格远远低于其他同样性能的紧固件类型，并且它小巧的尺寸设计可以在没有预留多少空间的情况下而很好的配合原来的产品。有别于其他的经济措施，使用螺套在增加质量和性能的同时又能降低整个产品的成本。螺套可以用于更薄更轻的材料而又不会牺牲螺纹强度。

螺套可以很好的保护螺纹，对松动，脱落，腐蚀，耐磨都有更好的特性。PowerCoil螺套采用奥氏体不锈钢制成，抗拉强度超过200000PSI,螺套硬度可达HRC43-50。螺套的内表面有着很好的表面精度，几乎可以消除由于摩擦而造成的磨损。

螺套菱形表面的设计需要足够的强度，以支持内外螺纹的连接。PowerCoil螺套可以安装在小尺寸的，没有压缩的范围之内（比如法兰），在节约重量与空间的同时提升螺纹强度。与螺栓公称直径相等的通常足以满足要求。

根据产品规格的不一样，有着很大范围的安装工具可供选择。在使用数量比较小的情况下，手动的安装工具会更加适合，而数量在非常大的情况下，那么电动和气动的安装工具是最为合适的。

#### 强度

由于螺纹护套的特殊设计，它所制造的内螺纹大大的改善了残余应力的分布情况。在前三个螺纹孔上承担了70%的剪切力。螺套使螺栓与安装螺套的那螺纹底孔之间形成弹性连接，因而消除了内外螺纹之间的螺距和牙型半角误差。可在规定的长度上使每圈螺纹上的负荷均匀分布。

我们可以看到，在低强度的材料上，螺栓强度是越短越小为佳。

自由状态下的螺套直径比其欲装入的螺孔直径稍大，那么装入螺套后，一个由外向内的力对螺套进行施压，每圈都能最大可能性的独立的接触到基底材料。这样在静态和动态时的承载力都会增加。

标准螺栓 使用PowerCoil品牌螺套后的螺栓

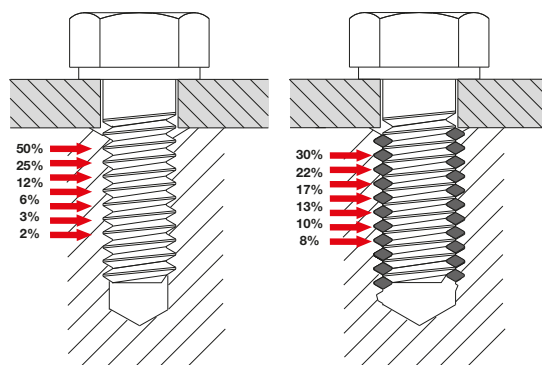

#### 应力的消除

在没有堆放，锁定，或者到位的时候，应力是不存在的。当有外力的时候，外圈会给予一个应力，把螺套推倒一个合适的位置。

#### 耐磨损

由于减小了螺纹的摩擦系数，高硬度材料所制造的纹螺套所产生的内螺纹表面精度会非常的好。这种特性在需要多次安装与拆卸过程中是十分有利的。

低的摩擦系数可以提供很好的组装扭矩，这样可以使螺纹配合的更好。

#### 腐蚀保护

在一般的环境下，使用18/8奥氏体不锈钢生产的PowerCoil螺套更加的耐腐蚀。由于减少了在螺纹拆卸时产生的电流效应，增加了寿命。

在紧固系统中最严重的腐蚀就是电流效应。因为电解性，在不同材质的材料在相互接触的时候，腐蚀就会发生。所有的金属都体现着活跃的或者不活跃的特性，在活跃的时候，腐蚀性会增加。黄金和白金是最不活跃的，而镁和锌最为活跃。最为常见的电解质溶液是水溶液，因为高浓度的电解盐的存在，海水和含盐的液体特别具有腐蚀性。

最好的阻止腐蚀的方法是寻找一个合适的材料来消除电解质载体，有不锈钢制成的PowerCoil螺套是非钝化的，当把这样的螺套安装在铝镁材料为基底材料的工件上时就可以更好的保护材料，尽可能的减少腐蚀。

#### 一些常用的预防腐蚀的方法如下：

通过密封或封口的方式，独立基底材料于电解质中特殊的镀铬螺纹护套。这样的螺套提供一个屏障去减少腐蚀。此外，镀铬有着很好的润滑作用，在使用不锈钢螺栓的时候有着更好的性能。

使用抗腐蚀性好的或者复合螺栓。这些措施包括锌铬酸盐底漆(mil-8585)和镉铬酸盐底漆(mil-23377)。注：这种行为会造成精度的损失。因此有人建议用粘着只用于螺栓，而不应用于螺套。如果锌铬酸盐底漆适用于螺纹底孔，那么螺套的安装还是需要保持湿润的。

使用干性润滑剂的螺套，比如镀钼。这样也可以提供一定的耐腐蚀性。

根据实际的情况，当不会引起整体效果的时候，最好能够在紧固件的外部涂上油漆。

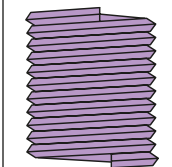
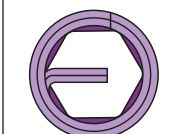
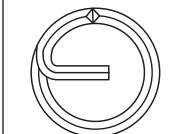
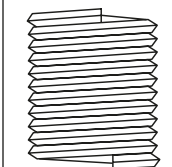
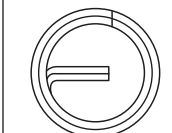

**材料**

PowerCoil标准螺套由具有航空标准的304 (18/8)奥氏体不锈钢制成,符合DTD 734A标准。包括316不锈钢以及一些特殊应用的表面涂层处理。

**可以选择的材料**

**磷青铜**

有色金属磷青铜合金螺套,符合BS2783 PB 102 EH,适用温度范围:-200°C至300°C。

**镍合金螺套**

耐高温高硬镍基合金(相当于SAE AS7246,DIN/NF-3018.W.NR 2.4669,UNS NO7750)。适用温度范围:-200°C至550°C。

**铌锰合金90**

耐高温高硬镍基合金符合BS2 HR 501(相当于W.NR 2.4632,UNS NO7090)。适用温度范围:-100°C至650°C。

螺套材料	最大温度		应用	涂层
	峰值	持续		
304不锈钢	425°C 800°F	315°C 600°F	通用所有材料	FL,AG,CD
316不锈钢	425°C 800°F	315°C 600°F	增加抗腐蚀能力, 盐水环境	FL,AG,CD
磷青铜	300°C 572°F	235°C 455°F	铜件,非磁性, 低渗透场合	AG,CD
镍合金	650°C 1200°F	550°C 1020°F	航空,汽轮机, 抗腐蚀,高温场合	AG
铌锰合金	650°C 1200°F	550°C 1020°F	航空,汽轮机领域	AG

**可选精度和涂层:**

**镀镉**

镀镉符合DTD904/DEF Stan 03-19(相当于FED,QQ-P-416,LN 9386)。镀镉可以及其优秀的屏蔽产生于不同金属间的电流腐蚀,它的高润滑功能可以更好的预防螺纹磨损。适用温度范围:-200°C至235°C。

镀镉产品不能用于以下场合:

- 温度超过235°C (455°F)
- 与油类接触
- 与饮用水,食品接触
- 由钛组成的期间(包括直接的或者间接的)因为在不断提升温度的情况下,它会变的较为脆弱。
- 镉具有很强的毒性—因此在运输,操作,安装时需特别小心。

**镀锌**

镀锌符合BS3328标准。镀锌可以获得最佳的电镀精度,在工业上有着广泛的应用。适用温度范围:-200°C至250°C。

**镀银**

镀银符合DTD 939标准。镀银在高温条件下具有保护螺纹的作用,常用于飞机引擎的紧固部分。适用温度范围:-200°C至650°C。镀银的螺纹护套可以安装于许多不同的材料上,比如铝合金,镁合金,耐腐蚀耐高温的材料等等。镀银的螺纹护套不推荐用于钛合金,因为这种合金很可能超过其服务温度300°C (570°F)。在所安装的材料上可能会出现由于银与钛的化合作用而产生的压力侵蚀。干性润滑剂涂层

固态的二硫化钼涂层符合MIL-L-0046010标准,提供了一个低摩擦系数的涂层并有着极好的承载能力。这种干性润滑剂涂层在螺纹元件和自锁应用的场合减少了很多麻烦。适用温度范围:-100°C至250°C。

涂层	零件号后缀	特殊标准及应用
镀银	AG	DTD 939
镀镉	CD	QQ-P-416 或者DEF STD 03-19
干性润滑剂	FL	MIL-L-8973, MIL-L-46010
红染料	-	自锁螺套或者特殊标识应用*

\*其他颜色染料也用于一些特殊的标识目的。

**选择正确的螺纹护套长度**

PowerCoil螺套有着品种齐全的螺纹护套。每种螺纹都有5种螺纹护套的长度可以选择。选择合适的螺纹护套长度对于获得螺栓张力及基底材料的剪切强度的平衡是非常重要的。5个螺套的长度(推荐PowerCoil品牌)1D,1.5D,2D,2.5D,3D在其下表格的阴影区域显示。这些都是在螺套没有安装(自由状态)情况下的计算测量值。这些值是螺套名义上的螺纹尺寸,直径。实际上的螺套安装后长度位于螺套长度选择表中。他们体现了实际的安装长度增加1/2英寸。根据下表可以选择合适的螺套长度,在这种长度情况下,产生一个足够强的螺纹系统,在基底材料损坏前,让螺栓先行碎裂,以保护基底材料。

母材的剪切力强度 (KPSI)	推荐的螺套公称长度 (基底材料剪切强度VS螺栓抗拉强度)									
	螺套长度					螺套长度				
54	75	96	108	125	132	160	180	220		
10	2.0	2.5	3.0	3.0	-	-	-	-	-	-
15	1.5	1.5	2.0	2.5	2.5	3.0	3.0	-	-	-
20	1.0	1.5	1.5	2.0	2.0	2.0	2.5	3.0	3.0	
25	1.0	1.0	1.5	1.5	1.5	2.0	2.0	2.5	2.5	
30	1.0	1.0	1.0	1.5	1.5	1.5	2.0	2.0	2.5	
40	1.0	1.0	1.0	1.0	1.0	1.5	1.5	1.5	2.0	
50	1.0	1.0	1.0	1.0	1.0	1.0	1.0	1.5	1.5	

例:如果母材的剪切强度为10KPSI,而螺栓的最小抗拉强度为54KPSI,那么此时正确的螺套长度为2.0倍直径(2.0D)。

母材的剪切力强度 (MPa)	螺套的最小抗拉强度 (MPa)									
	螺套长度					螺套长度				
70	300	400	500	600	800	1000	1200	1400		
100	1.5	2.0	2.5	2.5	-	-	-	-	-	-
150	1.0	1.5	1.5	2.0	2.5	3.0	-	-	-	-
200	1.0	1.0	1.5	1.5	2.0	2.0	2.5	3.0		
250	1.0	1.0	1.0	1.0	1.5	1.5	2.0	2.5		
300	1.0	1.0	1.0	1.0	1.0	1.5	1.5	1.5		
350	1.0	1.0	1.0	1.0	1.0	1.0	1.5	1.5		

例:如果母材的剪切强度为150MPa,而螺栓的最小抗拉强度为600MPa,那么此时正确的螺套长度为1.5倍直径(1.5D)。

**螺套规划**

PowerCoil的螺套设计都是根据标准的螺栓进行的,一些特殊的紧固件不属于其中。



螺栓需要整个的进入螺套以获得最大的力。为了防止仅仅只有局部接触，我们推荐螺套安装尾部总是需要去除的。这样就可以保证整个锁紧型螺套包含着螺栓的全部螺纹。如果设计参数反而需要预防这个现象，联系PowerCoil以获得帮助。

注意：

1. 螺栓的拉伸强度是特殊的最小值。当确认了螺套长度后，要考虑到螺栓所允许的最大抗拉强度。
2. 温度可能造成强度值的很大变化，有时候温度补偿是允许的
3. 重要的剪力值应该记住，因为基底材料所受的应力位于丝锥螺纹的最大直径处
4. 当强度值在2个值之间的时候，选择基底材料的最低剪力值或者螺栓的最高抗拉强度值。
5. 为了获得最大的值，螺栓长度及螺纹长度以及螺纹深度应该足以让螺栓整个儿插入。

#### 锁紧型（预扭力矩）螺纹护套

PowerCoil品牌锁紧型螺套是专为振动或者冲击的场合而设计的。锁紧型的螺套存在着一个预扭矩作为螺纹紧固件，防止在振动或者冲击的场合下松动。他们不再需要其他不太理想而昂贵的锁定机制。它们起着出色的“调节螺钉”的作用，防止紧固件滑落。

#### 锁紧型螺套是如何工作的

PowerCoil螺套提供一个更加安全的预锁紧扭矩。实现这一目标是在插入的长度上有着一个或多个多边形线圈，对阳螺纹向其子午线施加压力。

去除阳螺纹，锁线圈放松为原来的形式，允许多次使用，同时又能保留可测量水平扭矩。

请注意：

我们强烈的推荐在使用PowerCoil锁紧型螺套时，需要使用配合紧凑的，或者有润滑处理的螺栓。如果使用热处理过的螺栓或者不锈钢的螺栓时，必须注意到，有时会产生化合作用，比如钼，二硫化物等等。必须使用最小的抓紧力以获得最大的使用寿命。为了增加PowerCoil锁紧型螺套的使用寿命，推荐使用干性润滑剂涂层或者镀铬。

#### 锁紧线圈的位置：

对于1D,1.5D,2D长度的螺套，锁紧线圈的位置位于整个螺套普通型线圈的中部。对于2.5D,3D长度的螺套，锁紧线圈的位置与2D直径的螺套位置是一样的。锁紧型的螺套染成红色以更好的识别，这种染料如果需要的话，可以用酒精很轻易的去除。

#### 染成红色

PowerCoil锁紧型螺套有机的染成红色以易于标识。这种红色的染料不会影响按照，而且在需要的时候也可以很方便的去除，实际上，大多数的情况下，不需要去除。在一些需要去除的场合（比如在无尘式组装紧密仪器），那么在安装这种锁紧型的螺套前，需要预先在酒精中进行浸泡。

#### PowerCoil锁紧型螺套的扭矩值

公制粗牙MC			公制细牙MF		
螺纹	最大扭矩	最小扭矩	螺纹	最大扭矩	最小扭矩
mm*mm	(Nm)	(Nm)	mm*mm	(Nm)	(Nm)
M2.2x0.45	0.14	0.02	M8.0x1.00	6.00	0.80
M2.5x0.45	0.23	0.05	M10.0x1.00	10.50	1.40
M3.0x0.50	0.45	0.10	M10.0x1.25	10.50	1.40
M3.5x0.60	0.68	0.12	M12.0x1.25	15.50	2.10
M4.0x0.70	0.90	0.15	M12.0x1.50	15.50	2.10
M5.0x0.80	1.60	0.30	M14.0x1.50	23.50	3.00
M6.0x1.00	3.00	0.40	M16.0x1.50	31.50	4.20
M7.0x1.00	4.50	0.60	M18.0x1.50	42.00	5.50
M8.0x1.25	6.00	0.80	M20.0x1.50	54.00	7.00
M10.0x1.50	10.50	1.40	M22.0x1.50	67.50	9.00
M12.0x1.75	15.50	2.10	M18.0x2.00	42.00	5.50
M14.0x2.00	23.50	3.00	M20.0x2.00	54.00	7.00
M16.0x2.00	31.50	4.20	M22.0x2.00	67.50	9.00
M18.0x2.50	42.00	5.50	M24.0x2.00	80.00	10.50
M20.0x2.50	54.00	7.00	M27.0x2.00	94.00	12.00
M22.0x2.50	67.50	9.00	M30.0x2.00	108.00	14.00
M24.0x3.00	80.00	10.50	M33.0x2.00	122.00	15.50
M27.0x3.00	94.00	12.00	M36.0x2.00	136.00	17.50
M30.0x3.50	108.00	14.00	M39.0x2.00	150.00	19.50
M33.0x3.50	122.00	15.50	M36.0x3.00	136.00	17.50
M36.0x4.00	136.00	17.50	M39.0x3.00	150.00	19.50
M39.0x4.00	150.00	19.50			

锁紧型螺套符合MP3329, MP3330, MP3331标准

#### PowerCoil锁紧型螺套的扭矩值

统一标准粗牙螺纹-UNC			统一标准细牙螺纹-UNF		
螺纹	最大扭矩	最小扭矩	螺纹	最大扭矩	最小扭矩
Inch*TPI	(lb in)	(lb in)	Inch*TPI	(lb in)	(lb in)
2x56	1.25	0.19	3x56	0.13	0.44
3x48	2.00	0.44	4x48	0.19	0.63
4x40	3.00	0.63	6x40	6.00	1.00
5x40	4.69	0.81	8x36	9.00	1.50
6x32	6.00	1.00	10x32	13.00	2.00
8x32	9.00	1.50	1/4x28	30.00	3.50
10x24	13.00	2.00	5/16x24	60.00	6.50
12x24	24.00	3.00	3/8x24	80.00	9.50
1/4x20	30.00	4.50	7/16x20	100.00	14.00
5/16x18	60.00	7.50	1/2x20	150.00	18.00
3/8x18	80.00	12.00	9/16x18	200.00	24.00
7/16x14	100.00	16.50	5/8x18	300.00	32.00
1/2x13	150.00	24.00	3/4x16	400.00	50.00
9/16x12	200.00	30.00	7/8x14	600.00	70.00
5/8x11	300.00	40.00	1x12	800.00	90.00
3/4x10	400.00	60.00	11/8x12	900.00	117.00
7/8x9	600.00	82.00	11/4x12	1000.00	143.00
1x8	800.00	110.00	13/8x12	1150.00	165.00
11/8x7	900.00	137.00	11/2x12	1350.00	190.00
11/4x7	1000.00	165.00			
13/8x6	1150.00	185.00			
11/2x6	1350.00	210.00			

锁紧型螺套符合NASM8846标准

注意：这些值是螺栓完全进入螺套所需的最大值

PowerCoil锁紧型螺套可以根据客户的需要进行定制。此时，预扭矩的力可以根据情况的不同略有增加或者减少以满足特定的应用。这时，请联系当地的代理商以讨论合适的应用。

注意：安装PowerCoil锁紧型螺套需要特殊的预拉伸工具，请向PowerCoil代理商进行咨询。



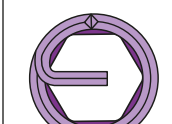
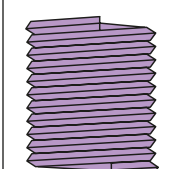
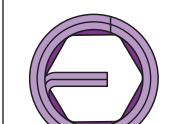
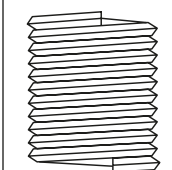
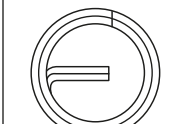
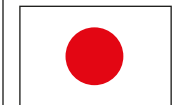

PowerCoil(パワーコイル)のワイヤースレッドインサートは高品質クロムニッケルステンレス鋼ワイヤーから製造されており、温度変化や腐食の影響に強い高強度の内部ねじ山を形成します。PowerCoil(パワーコイル)の特殊なデザインが生み出すねじ山は、他のどんな一点締結法も及ばない優れた複合性能を持ちます。PowerCoil(パワーコイル)のスレッドインサートにはフリーランニングとロックタイプの二種類があり、どちらも同類のスレッドインサート製品よりはるかに軽量化、低コスト化されています。また、小型化に成功したPowerCoil(パワーコイル)のインサートは、通常、母材に特別な設計を加えることなく使用することが可能です。

#### フリーランニング

PowerCoil(パワーコイル)のフリーランニングインサートは、スプリング状に巻かれた高精度オーステナイト系ステンレス鋼ワイヤーから造られており、多様な手動および電動の挿入工具の1つを使用して装着した後は、温度変化や腐食に強い耐久性を示す永久的な内部ねじ山を形成します。装着後のインサート位置は、インサートがタップ孔より一回り大きめに設計されている為に生じるインサートとタップ孔側面間の半径方向の圧力によって保持されます。

#### ロックタイプ

ロックタイプ(プリベリントルク)インサートは周期的な振動や衝撃を受ける機械への使用に最適な製品です。フリーランニングインサートの利点に加えプリベリントルクによる締結力を持ち、より強力な固定力を示します。インサート中のコイル1-2巻きが多角形のグリップコイルとなっており、この部分がおねじの側面を締め付け強力な締結力を与えます。これらのグリップコイルは幾つかの接線に沿ったロックングコードを持ち、これが通常のフリーランニングコイルの内径に突き出した形状となっています。おねじがインサートのロック部分を進んでいくにつれて、突出部が押し込まれこの半径方向の圧力(プリベリントルク)がおねじを更に強く締め付けます。おねじを取り出した場合、ロックングコイルは再び元の形状に戻り十分なプリベリントルクを維持するため繰り返し使用が可能です。

注:ロックタイプインサートには高密着メッキ処理又は潤滑剤を塗装したボルト又はスクリューの使用をお勧めします。

#### 製品の特徴と利点

いままで、らせん状ワイヤースレッドインサートは損傷したねじ目を補修するための製品と誤解されてきたために、その高い利用価値は軽視されてきました。

らせん状ワイヤースレッドインサートは同種のスレッドインサートと比較し、はるかに軽量化、低コスト化されており、そのコンパクトなサイズから、通常、既存設計に変更を加えることなく使用することが可能です。また他の多くの経済戦略と異なり、PowerCoil(パワーコイル)インサートを導入することによって、経営全体のコスト削減が可能になるだけでなく製品の品質や性能を高めることも可能となります。PowerCoil(パワーコイル)インサートの使用で、ねじ山の締結力を損うことなく母材をより薄く軽量化することができます。

オーステナイト系ステンレス鋼ワイヤーから造られるPowerCoil(パワーコイル)ワイヤースレッドインサートは、剥離、焼付、侵食、磨耗作用によって起こるめねじの損傷を防ぎ、200,000 psi以上の引っ張り強度とRc43-50の強固度を持ちます。インサート表面は非常に滑らかな仕上げがされており、摩擦によるめねじの損傷を防いでいます。

菱形のワイヤーで造られた連続的ならせん状コイル形状により、内部と外部のスレッドを保持するための厚い構造が不要となりました。PowerCoil(パワーコイル)インサートは、小さなボスやフランジ、またスペースの制限がある部分にも使用可能なので、高い締結力を保持したままスペースや重量の軽減化に貢献します。通常、ボス半径はボルト径と同等あれば十分です。

パワーコイルでは、それぞれの使用用途に適したインサート挿入工具を用意しています。小規模または補修作業用には手動挿入工具が、大規模な工程には電動式、エア式工具が準備してあります。

#### 製品の長所

ワイヤースレッドインサートの高い柔軟性によって、今までのタップ孔と比較し応力が一部に集中することなく全体に分配されます(インサート未装着の場合、最初の3山にせん断力の70%近くがかかる)。インサートの高い柔軟性によって、通常のタップ孔に存在するねじ山のピッチと角度の誤差の補正を助け、これによって得られた残留力をらせん状のフープ応力へ変換しタップ孔側面へ分配することが可能となります。これによって荷重許容量は大きく改善されます。これらの長所によって、設計に際し強度の低い素材に対してはもボルト強度を基に安心して小さな短いねじ山を使用することが出来ます。

高い引張り強度を持つコイルから造られるワイヤースレッドインサートは、挿入時に軽く絞り込まれ、装着後は外向きに働くバネ作用によって一定位置に固定されます。各コイルは母材と最大の接触面を持つよう伸縮し、静的および動的荷重許容量が改善されます。

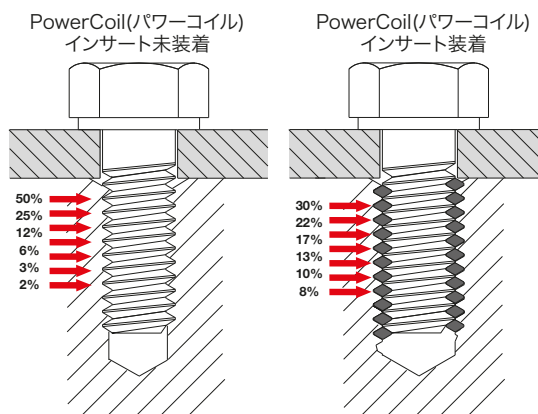

#### 母材へのゼロ負荷

PowerCoil(パワーコイル)インサートの装着には杭打ち、締め付け、スエーピング、キーイングなどの工程が無いことから、母材にかかる負担は事実上ゼロです。インサートの外向きに働くバネ作用がインサートを一定位置に固定します。

#### 耐摩耗性

素材の高い硬度と表面の滑らかな仕上げにより、パワーコイルインサートのねじ山の磨耗は事実上ゼロとなり、組立てと解体頻度の高い用途にも最適なインサートとなります。低い摩擦係数を持つことによって、組立て工程の加力は事実上全て締結力へと変換され、強い固定力を持ちます。

#### 腐食防止

在一般的環境下、使用18/8奥氏体不銹鋼的PowerCoil螺套更加的耐腐PowerCoil(パワーコイル)インサートに使用されている18/8オーステナイト系ステンレス鋼ワイヤーは、通常の使用環境において耐腐食性を持ちます。組立部におけるガルバニック作用による影響が減少し耐久性も高まります。

ガルバニック腐食はインサートと締め具に最も大きな影響を与える腐食作用で、電位差のある金属が電解質溶液を媒体として接触した場合に生じます。全ての金属は特有の電気的活性度と非活性度を持ち、活性度順に金属が並べられたものが電位列です。金と白金が最も電位が高く(貴の金属)で、亜鉛とマグネシウムが最も電位が低い(卑な金属)となります。最も頻繁に影響を与える電解質は水で、海水または塩水噴霧では淡水より溶解塩分が多いため、腐食作用が進行し易くなります。

ガルバニック腐食を防止する最善の方法としては、電位差の少ない金属を使い電解質との接触を避けることです。パワーコイルワイヤースレッドインサートに使われているステンレス鋼は不動態化されていないため、アルミニウムやマグネシウムの母材に装着した場合のガルバニック腐食の危険を最小に抑えることが出来ます。この他に、ガルバニック腐食を防ぐ為には以下のような予防策が効果的です。

締め具と電解質の接触を防ぎ、ガスケットやシーリングを使用するカドミウムメッキのインサートを使用する。カドミウムメッキはインサート表面に防食層を形成して腐食を防ぎます。またカドミウムメッキはステンレス鋼ねじが使用された場合に潤滑材としての役割も果たしかじりを防止します。

亜鉛クロメートプライマー(MIL-P-8585)やストロンチウムクロメートプライマー(MIL-P-23377)などの腐食防止ペーストまたはコンパウンドをねじに塗る。注:コイルスレッドインサートにペーストを塗った場合、ペーストの一部がワイヤーと孔の間に入り適正な公差が得られない場合があります。この問題を防ぐ為に、ペーストはインサートには塗らず、ねじのみ塗ることをお勧めします。また、亜鉛クロメートプライマーをタップ孔に塗る場合は、薄めてから少量使用することをお勧めします。インサートはプライマーが乾く前に挿入して下さい。

モリブデンジスルフィドなどのドライフィルム潤滑材をインサートに使用することによって、第二の防食層を形成させる。組立て完成した機器等に支障を与えない場合は、外部接合部に適切な塗装を施す。

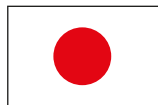

PowerCoil(パワーコイル)標準インサートは、高品質を保証された航空機材用の品質を持つ304 (18/8)オーステナイト系ステンレス鋼から造られており、DTD 734A規格に準拠しています。また、316ステンレス鋼や各用途に適したコーティングも使用しています。

その他の材質  
りん青銅  
BS2783 PB 102 EHに準じた銅とすずの非鉄合金で-200°Cから+300°C範囲の用途向け  
インコネルX-750  
耐熱性があり析出硬化するニッケル合金(SAE AS 7246 DIN/NF 3018, W.NR 2.4669, UNS N07750規格と同基準)で、-200°Cから+550°C範囲の用途向け  
ナイモニック 90  
BS2 HR 501規格(W.NR 2.4632, UNS N07090規格と同基準)に準拠する耐熱性があり析出硬化するニッケル合金で、-100°Cから+650°C範囲の用途向け

インサート材質	最高温度		主な用途	コーティング
	ピーク時	継続的		
304ステンレス	425°C 800°F	315°C 600°F	全ての金属の一般用途向け	FL,AG,CD
316ステンレス	425°C 800°F	315°C 600°F	高い防食性を持ち、海上用途向け	FL,AG,CD
りん青銅	300°C 572°F	235°C 455°F	銅部品、非磁性、低磁性用途向け	AG,CD
インコネル X-750	650°C 1200°F	550°C 1020°F	航空宇宙、タービン、腐食性環境、高温用途	AG
ナイモニック 90	650°C 1200°F	550°C 1020°F	航空宇宙、タービン用途向け	AG

仕上げとコーティング  
カドミウムメッキ  
DTD904-Def Stan 03-19規格(FED, QQ-P-416, LN 9368規格と同基準)に準じ電氣的にカドミウムを付着させたカドミウムメッキは、電位差のある金属間でのガルバニック腐食を防ぐ優れたバリアーの役割を果たし、その高い潤滑性と防食性からねじ部品間の焼付けやかじりを防ぎます。カドミウムメッキは-200°Cから+235°C範囲の用途向けです。ただしカドミウムメッキ部品は次のような用途には使用できません

- +235°C(+455°F)以上
- 燃料や高温の油と接触する場合
- 食品や飲料水と接触する場合
- 高温で脆化して破損する恐れがあるため、チタン部品と(直接的または間接的に)一緒に使用する場合
- カドミウムは非常に毒性の強い物質ですので取り扱いには十分に注意して下さい

亜鉛メッキ  
BS 3382規格に従い電氣的に付着された亜鉛メッキは、業界で最も広く普及している電気メッキです。亜鉛は-200°Cから+250°C範囲の用途向けです。

銀メッキ  
DTD 939規格に従い電氣的に付着された銀メッキは、高温使用時における焼付けや磨耗防止の役目を果たし、航空機用エンジンファスナーに広く使用されています。銀メッキは-200°Cから+650°C範囲の用途向けです。アルミニウム合金、マグネシウム合金、耐食及び耐熱材など様々な材質に使用できません。

銀メッキインサートは次の用途にお勧めしません  
使用温度が300°C(570 °F)を超える恐れのあるチタン合金への使用。内部で銀とチタンの応力腐食が発生する危険があります。

ドライフィルム潤滑材  
MIL-L-0046010規定に従い固体薄膜熱処理されたモリブデンジスルフィドドライフィルム潤滑材によるコーティングは低い摩擦係数と高い荷重許容性を与え、部品間の焼付けやかじりを

防ぎます。特にロックタイプインサートへの使用に効果があります。ドライフィルム潤滑材は-100°Cから+250°C範囲の用途向きです。

メッキ/仕上げ	部品番号, 接尾字	関連規格用
銀メッキ	AG	DTD 939
カドミウムメッキ	CD	QQP-416または DEF STD 03-19
ドライフィルム潤滑材	FL	MIL-L-8937または MIL-L-46010
着色(赤色)	-	識別の為にロックタイプインサートは赤色に着色してあります*

\*特別な識別目的で、赤色以外の着色がされる場合もあります

適正なインサートの長さの選定方法  
PowerCoil(パワーコイル)ワイヤースレッドインサートは一般に使用されている全てのねじ規格に対応しています。各ねじサイズ毎に5種類のインサート長があり、適正なインサートの長さを選ぶことはボルトの引っ張り強度と母材のせん断強度のバランスを取る上で非常に重要となります。5種類のインサートの長さ(パワーコイルワイヤースレッドインサート使用時の推奨値)、1D、1.5D、2D、2.5D、3Dは次の表の影になった部分に示されています。未挿入時のインサートからはこれらの数値は測定出来ないため、表の値はインサートのねじ山サイズまたは径の倍数として計算されています。装着状態での実際のインサートの長さはインサート選定表に示されており、実際の挿入深さに1/2ピッチが加算された値となっています。次の表を用いて選定されたインサートの長さは、母材またはインサートが破損する前またはボルトが抜ける前にボルトが破損する長さです。

母材強度とボルト強度を基に選定した呼びインサートの長さ

母材のせん断強度 (KPSI)	ユニファイ ボルトの最低極限引張り強度 (KPSI)								
	54	75	96	108	125	132	160	180	220
10	2.0	2.5	3.0	3.0	-	-	-	-	-
15	1.5	1.5	2.0	2.5	2.5	3.0	3.0	-	-
20	1.0	1.5	1.5	2.0	2.0	2.0	2.5	3.0	3.0
25	1.0	1.0	1.5	1.5	1.5	2.0	2.0	2.5	2.5
30	1.0	1.0	1.0	1.5	1.5	1.5	2.0	2.0	2.5
40	1.0	1.0	1.0	1.0	1.0	1.5	1.5	1.5	2.0
50	1.0	1.0	1.0	1.0	1.0	1.0	1.0	1.5	1.5

例:母材のせん断強度が10KSIでボルトの引っ張り強度が54KSIの場合、適正なインサートの長さはインサートの径の2.0倍(2D)となります

母材の剪断力強度 (MPa)	メートル 螺絲の最小抗拉強度 (MPa)							
	300	400	500	600	800	1000	1200	1400
70	1.5	2.0	2.5	2.5	-	-	-	-
100	1.0	1.5	1.5	2.0	2.5	3.0	-	-
150	1.0	1.0	1.5	1.5	2.0	2.0	2.5	3.0
200	1.0	1.0	1.0	1.0	1.5	1.5	2.0	2.5
250	1.0	1.0	1.0	1.0	1.0	1.5	1.5	2.0
300	1.0	1.0	1.0	1.0	1.0	1.5	1.5	1.5
350	1.0	1.0	1.0	1.0	1.0	1.0	1.5	1.5

例:母材のせん断強度が150MPaでボルトの引っ張り強度が600MPaの場合、適正なインサートの長さはインサートの径の1.5倍(1.5D)となります

ボルトの突起  
PowerCoil(パワーコイル)のワイヤースレッドインサートは特別な工具を必要としない一般に使用されている標準規格のボルトとねじに対応します。

組立て後の最大強度は、ボルトのねじ部がインサート全てにかみ合った時に得られます。完全にボルトとインサートがかみ合うようにするためには、タングを折取ることをお勧めします。また、タングを折り取ることによってロックリングコイルが完全にボルトのねじ部とかみ合ったことを確認できます。設計上の理由でこれが可能でない場合は、PowerCoil(パワーコイル)にご相談ください。

**注意:**

表に示されたボルト引張り強度は仕様上の最小値です。インサートの長さを選定する際には、ボルトの設計仕様書または購入仕様書に示された最大引張り強度も考慮して下さい

使用温度によって強度に大きなばらつきが出るので、温度による補正が必要となります

母材はタップ孔のねじ山の外径部分でせん断応力を受ける為、母材せん断強度は重要な要素となります

強度が表の数値の中間値となった場合、次に低い母材せん断強度または次に高いボルト引張り強度を選んでください

最適な最大強度を得るためには、ボルトの長さ、ボルトねじ山の長さ、タップ孔の深さがインサート全てがかみ合うのに十分な値を持つ必要があります

**ロックタイプ(プリベリントルク)インサート**

PowerCoil(パワーコイル)のロックタイプインサートは、周期的な振動や衝撃を受ける環境下での用途用に設計されています。ロックタイプインサートはプリベリントルクでおねじを締め付け、振動や衝撃によるボルトの緩みを防ぐため、このような用途に最適といえなく、さらにコストのかかる他の戻り止め機構を採用する必要がなくなります。ボルトのクリープを抑えるロックタイプインサートは調整ねじなどの用途に最適です。

**ロックタイプインサートの仕組み**

PowerCoil(パワーコイル)ロックタイプインサートはプリベリントルクによって、さらに強力な締結力を与えます。ロックタイプインサートでは、インサート中のコイル1-2巻きが多角形のグリップコイルとなっており、この部分がおねじの側面を締め付け強力な締結力を与えます。これらのグリップコイルは幾つかの接線に沿ったロックリングコードを持ち、これがフリーランニングコイルの内径に突き出した形状となっています。おねじがインサートのロック部分を進んでいくにつれて、突出部が押し込まれこの半径方向への圧力(プリベリントルク)がおねじを更に強く締め付けます。おねじを取り出した場合、ロックリングコイルは再び元の形状に戻り大きなプリベリントルクを維持するために繰り返し使用が可能です。

ただし次の点にご注意ください:

ロックタイプインサートには高密度メッキ処理又は潤滑材を塗装したボルトまたはねじの使用をお勧めします。熱処理されたメッキ無しボルトまたはステンレス鋼のボルトを使用する場合は、かじりの影響を最小にしサイクル寿命を最大にするためにモリブデンジスルフィドなどの焼付防止コンパウンドの使用をお勧めします。また、ねじやボルトの磨耗寿命を延ばすためには、ドライフィルム潤滑材またはカドミウムメッキされたPowerCoil(パワーコイル)インサートの使用をお勧めします。

**ロックリングコイル位置**

1D、1.5D、2Dの長さを持つインサートでは、ロックリングコイルの中心位置は自由コイル数の1/2となります。2.5Dと3Dのインサートは、2Dインサートのロックリングコイル中心位置のタングからの距離と同じ値となります。

ロックタイプインサートは識別し易いように赤色に着色してありますが、希望であればアルコール液で取り除くことが可能です。

**着色(赤色)**

PowerCoil(パワーコイル)のロックタイプインサートは通常識別のために有機赤色染料で着色されています。この染料はインサートの装着や性能に影響を与えないため、(ほとんどの場合)取り除く必要はありませんが、クリーンルームでの精密機器の組立などで塗料の付着が望ましくない場合には、インサート挿入前に変性アルコール液に浸すことで染料を取り除くことができます。

**PowerCoil(パワーコイル) ロックリングインサートトルク値**

ミリ並目			ミリ細目		
ねじ山 mm*mm	最大トルク (Nm)	最小トルク (Nm)	ねじ山 mm*mm	最大トルク (Nm)	最小トルク (Nm)
M2.2x0.45	0.14	0.02	M8.0x1.00	6.00	0.80
M2.5x0.45	0.23	0.05	M10.0x1.00	10.50	1.40
M3.0x0.50	0.45	0.10	M10.0x1.25	10.50	1.40
M3.5x0.60	0.68	0.12	M12.0x1.25	15.50	2.10
M4.0x0.70	0.90	0.15	M12.0x1.50	15.50	2.10
M5.0x0.80	1.60	0.30	M14.0x1.50	23.50	3.00
M6.0x1.00	3.00	0.40	M16.0x1.50	31.50	4.20
M7.0x1.00	4.50	0.60	M18.0x1.50	42.00	5.50
M8.0x1.25	6.00	0.80	M20.0x1.50	54.00	7.00
M10.0x1.50	10.50	1.40	M22.0x1.50	67.50	9.00
M12.0x1.75	15.50	2.10	M18.0x2.00	42.00	5.50
M14.0x2.00	23.50	3.00	M20.0x2.00	54.00	7.00
M16.0x2.00	31.50	4.20	M22.0x2.00	67.50	9.00
M18.0x2.50	42.00	5.50	M24.0x2.00	80.00	10.50
M20.0x2.50	54.00	7.00	M27.0x2.00	94.00	12.00
M22.0x2.50	67.50	9.00	M30.0x2.00	108.00	14.00
M24.0x3.00	80.00	10.50	M33.0x2.00	122.00	15.50
M27.0x3.00	94.00	12.00	M36.0x2.00	136.00	17.50
M30.0x3.50	108.00	14.00	M39.0x2.00	150.00	19.50
M33.0x3.50	122.00	15.50	M36.0x3.00	136.00	17.50
M36.0x4.00	136.00	17.50	M39.0x3.00	150.00	19.50
M39.0x4.00	150.00	19.50			

**PowerCoil(パワーコイル) ロックリングインサートトルク値**

ユニファイ並目-UNC			ユニファイ細目-UNF		
ねじ山 Inch*TPI	最大トルク (lb in)	最小トルク (lb in)	ねじ山 Inch*TPI	最大トルク (lb in)	最小トルク (lb in)
2x56	1.25	0.19	3x56	0.13	0.44
3x48	2.00	0.44	4x48	0.19	0.63
4x40	3.00	0.63	6x40	6.00	1.00
5x40	4.69	0.81	8x36	9.00	1.50
6x32	6.00	1.00	10x32	13.00	2.00
8x32	9.00	1.50	1/4x28	30.00	3.50
10x24	13.00	2.00	5/16x24	60.00	6.50
12x24	24.00	3.00	3/8x24	80.00	9.50
1/4x20	30.00	4.50	7/16x20	100.00	14.00
5/16x18	60.00	7.50	1/2x20	150.00	18.00
3/8x18	80.00	12.00	9/16x18	200.00	24.00
7/16x14	100.00	16.50	5/8x18	300.00	32.00
1/2x13	150.00	24.00	3/4x16	400.00	50.00
9/16x12	200.00	30.00	7/8x14	600.00	70.00
5/8x11	300.00	40.00	1x12	800.00	90.00
3/4x10	400.00	60.00	11/8x12	900.00	117.00
7/8x9	600.00	82.00	11/4x12	1000.00	143.00
1x8	800.00	110.00	13/8x12	1150.00	165.00
11/8x7	900.00	137.00	11/2x12	1350.00	190.00
11/4x7	1000.00	165.00			
13/8x6	1150.00	185.00			
11/2x6	1350.00	210.00			

ロックリングトルク値は  
NASM8846に従う

注:最大の強度を得るためには、ボルトとインサートコイル全てがかみ合うことが重要となります  
PowerCoil(パワーコイル)のロックタイプインサートは顧客の特別な要望に合わせ設計することができます。場合によっては、プリベリントルクを減少させたり増加させることによって特殊な用途に対応させます。特殊な要望がありましたら、お気軽にPowerCoil(パワーコイル)へご相談ください。注:PowerCoil(パワーコイル)のロックタイプインサートの装着にはプレインダー式挿入工具が必要となります。他の挿入方法オプションに関しては、PowerCoil(パワーコイル)取り扱い店へお問い合わせください。

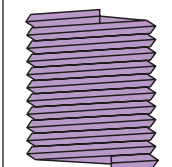
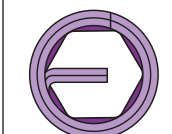
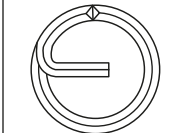
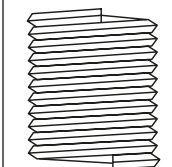
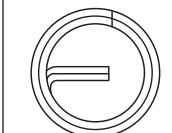
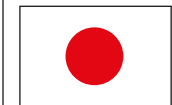















Optimum thread performance with Wire Thread Inserts is achieved when the inserts are installed 1/2 to 1 pitch below the surface of the tapped hole. This means that the actual length of an installed insert is equal to dimension Q less 1/2 to 1 pitch. Dimensions S and T allow for tap end clearance of intermediate taps. When using Bottoming and Spiral Flute Taps these dimensions may be reduced by an amount equal to 2 thread pitches. Any countersink depths must be added to these dimensions.

\* B Major Diameter is listed for tap identification only. Slight variance of this dimension is expected and has no bearing on correct fit and tolerance of the wire thread after installation.

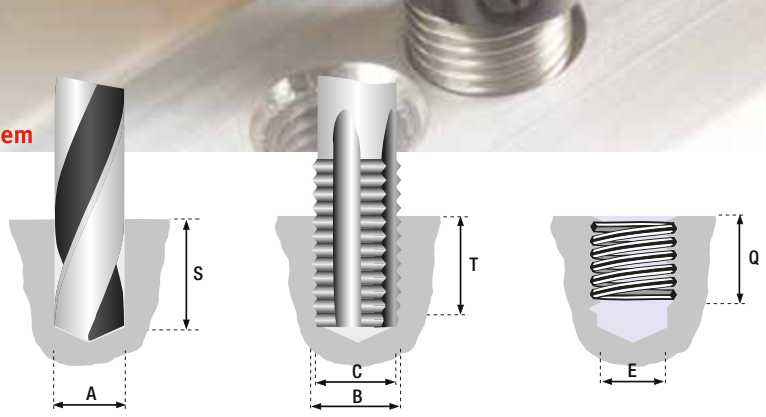

Nominal Thread Size	DRILLED HOLE DIMENSIONS									Nominal Thread Size	TAPPED HOLE DIMENSIONS							E Fitted Minor Dia.	
	Drill				S Min. Drilling Depth Inter/Plug Tap						B Major Dia. *	C Pitch Diameter		T Minimum Tapping Depth					
	Size		A Minor Dia.		1D	1,5D	2D	2,5D	3D			Minimum	Normal	1D	1,5D	2D	2,5D		3D
mm	inch	inch	inch	inch	inch	inch	inch	inch	inch	inch	inch	inch	inch	inch	inch	inch	inch		
<b>BA</b>																			
<b>6BA</b>	2,90	#33	0,113	0,116	0,204	0,259	0,314	0,369	0,424	<b>6BA</b>	0,134	0,1226	0,1252	0,183	0,238	0,293	0,348	0,404	0,0850
<b>5BA</b>	3,40	#29	0,129	0,135	0,230	0,293	0,356	0,419	0,482	<b>5BA</b>	0,152	0,1399	0,1426	0,207	0,270	0,333	0,396	0,459	0,0980
<b>4BA</b>	3,80	#25	0,147	0,152	0,259	0,329	0,400	0,471	0,542	<b>4BA</b>	0,171	0,1574	0,1605	0,233	0,303	0,374	0,445	0,516	0,1106
<b>3BA</b>	4,30	11/64	0,166	0,171	0,291	0,371	0,452	0,533	0,613	<b>3BA</b>	0,194	0,1786	0,1821	0,262	0,343	0,423	0,504	0,585	0,1268
<b>2BA</b>	4,90	#10	0,191	0,196	0,328	0,421	0,513	0,606	0,698	<b>2BA</b>	0,221	0,2042	0,2079	0,297	0,389	0,482	0,574	0,667	0,1468
<b>1BA</b>	5,50	7/32	0,213	0,220	0,368	0,472	0,576	0,681	0,785	<b>1BA</b>	0,249	0,2299	0,2342	0,333	0,437	0,541	0,646	0,750	0,1661
<b>0BA</b>	6,20	C	0,241	0,246	0,413	0,531	0,649	0,768	0,886	<b>0BA</b>	0,281	0,2598	0,2645	0,374	0,492	0,610	0,728	0,846	0,1890
<b>BSC</b>																			
<b>3/16 - 32</b>	5,10	13/64	0,195	0,205	0,330	0,420	0,520	0,610	0,700	<b>3/16 - 32</b>	0,232	0,2136	0,2112	0,300	0,390	0,480	0,580	0,670	0,1543
<b>1/4 - 26</b>	6,60	17/64	0,258	0,270	0,420	0,550	0,670	0,800	0,920	<b>1/4 - 26</b>	0,304	0,2817	0,2790	0,380	0,510	0,630	0,760	0,880	0,2090
<b>5/16 - 26</b>	8,00	5/16	0,320	0,332	0,490	0,640	0,800	0,950	1,110	<b>5/16 - 26</b>	0,367	0,3444	0,3415	0,450	0,600	0,760	0,920	1,070	0,2715
<b>3/8 - 26</b>	9,80	25/64	0,383	0,395	0,550	0,740	0,920	1,110	1,300	<b>3/8 - 26</b>	0,429	0,4070	0,4040	0,510	0,700	0,880	1,070	1,260	0,3340
<b>7/16 - 26</b>	11,10	7/16	0,446	0,457	0,610	0,830	1,050	1,270	1,490	<b>7/16 - 26</b>	0,492	0,4697	0,4665	0,570	0,790	1,010	1,230	1,450	0,3965
<b>1/2 - 26</b>	12,70	1/2	0,508	0,520	0,670	0,920	1,170	1,420	1,670	<b>1/2 - 26</b>	0,554	0,5323	0,5290	0,630	0,880	1,130	1,380	1,630	0,4590
<b>9/16 - 26</b>	14,75	37/64	0,571	0,582	0,740	1,020	1,300	1,580	1,860	<b>9/16 - 26</b>	0,617	0,5945	0,5915	0,700	0,980	1,260	1,540	1,820	0,5215
<b>5/8 - 26</b>	16,30	41/64	0,633	0,645	0,800	1,110	1,420	1,740	2,050	<b>5/8 - 26</b>	0,679	0,6575	0,6540	0,760	1,070	1,380	1,700	2,010	0,5840
<b>3/4 - 26</b>	19,50	49/64	0,758	0,769	0,920	1,300	1,670	2,050	2,420	<b>3/4 - 26</b>	0,804	0,7827	0,7790	0,880	1,260	1,630	2,010	2,380	0,7090
<b>1 - 24</b>	25,75	1.1/64	1,009	1,020	1,190	1,690	2,190	2,690	3,190	<b>1 - 24</b>	1,059	1,0355	1,0314	1,150	1,650	2,150	2,650	3,150	0,9556

Nominal Thread Size	DRILLED HOLE DIMENSIONS									Nominal Thread Size	TAPPED HOLE DIMENSIONS							E Fitted Minor Dia.		
	Drill				S Min. Drilling Depth Inter/Plug Tap						B Major Dia. *	C Pitch Dia.		Tap Std.	T Minimum Tapping Depth					
	Size		A Minor Dia.		1D	1,5D	2D	2,5D	3D			Min	3B		1D	1,5D	2D		2,5D	3D
mm	inch	inch	inch	inch	inch	inch	inch	inch	inch	inch	inch	inch	inch	inch	inch	inch	inch	inch		
<b>8-UN</b>																				
<b>1.1/8 - 8</b>	28,50	1.1/8	1,130	1,155	1,690	2,250	2,810	3,380	3,940	<b>1.1/8 - 8</b>	1,261	1,1688	1,1757	1,1/4	1,560	2,130	2,690	3,250	3,810	-
<b>1.1/4 - 8</b>	32,00	1.1/4	1,255	1,280	1,810	2,440	3,060	3,690	4,310	<b>1.1/4 - 8</b>	1,386	1,2938	1,3008	1.3/8	1,690	2,310	2,940	3,560	4,190	-
<b>1.3/8 - 8</b>	35,00	1.3/8	1,380	1,405	1,940	2,620	3,310	4,000	4,690	<b>1.3/8 - 8</b>	1,511	1,4188	1,4259	1.1/2	1,810	2,500	3,190	3,880	4,560	-
<b>1.1/2 - 8</b>	38,00	1.1/2	1,505	1,530	2,060	2,810	3,560	4,310	5,060	<b>1.1/2 - 8</b>	1,636	1,5438	1,5510	1.5/8	1,940	2,690	3,440	4,190	4,940	-
<b>1.5/8 - 8</b>	41,00	1.5/8	1,630	1,655	2,190	3,000	3,810	4,630	5,440	<b>1.5/8 - 8</b>	1,761	1,6688	1,6762	1.3/4	2,060	2,880	3,690	4,500	5,310	-
<b>1.3/4 - 8</b>	44,50	1.3/4	1,755	1,780	2,310	3,190	4,060	4,940	5,810	<b>1.3/4 - 8</b>	1,886	1,7938	1,8013	1.7/8	2,190	3,060	3,940	4,810	5,690	-
<b>1.7/8 - 8</b>	47,50	1.7/8	1,880	1,905	2,440	3,370	4,310	5,250	6,190	<b>1.7/8 - 8</b>	2,011	1,9188	1,9264	2	2,310	3,250	4,190	5,130	6,060	-
<b>2 - 8</b>	50,80	2	2,005	2,030	2,560	3,560	4,560	5,560	6,560	<b>2 - 8</b>	2,136	2,0438	2,0515	2.1/8	2,440	3,440	4,440	5,440	6,440	-

IMPORTANT The success of any drilling and tapping operation is dependant upon many factors – type of material being cut, cutting speed, coolant, equipment being used – and it is not possible to give specific drill sizes for each material. Drill sizes shown are recommendations only and PowerCoil would strongly suggest that independent testing be performed for specific and critical applications.

When using wire thread inserts it is important that the drilling and tapping diameters and lengths listed below are adhered to.

The figures outlined in these tables encompass effective free coil tolerances for most globally recognized standards and manufacturers, including those of reduced diameter wire thread inserts.

PowerCoil wire thread inserts can be manufactured to different standards upon request. Technical data on these standards can be obtained from our website – [www.powercoil.com.au](http://www.powercoil.com.au).

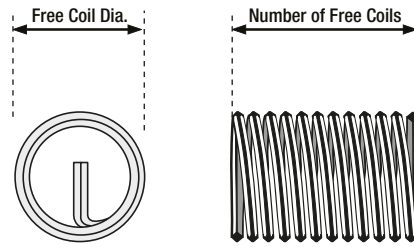

Nominal Thread Size	INSERT SPECIFICATIONS – FREE RUNNING – REDUCED DIAMETER																Nominal Thread Size	
	Q Nominal Length – installed					Free Coil Diameter		Number of Free Coils ± 1/4 coil counted 90° from Tang										
	1D	1,5D	2D	2,5D	3D	Min	Max	1D		1,5D		2D		2,5D		3D		
	inch	inch	inch	inch	inch	inch	inch	Min	Max	Min	Max	Min	Max	Min	Max	Min		Max
<b>BA</b>																	<b>BA</b>	
<b>6BA</b>	0,110	0,165	0,220	0,275	0,331	0,14	0,15	3,30	3,60	5,60	6,20	7,90	8,70	10,20	11,20	12,50	13,80	<b>6BA</b>
<b>5BA</b>	0,126	0,189	0,252	0,315	0,378	0,15	0,17	3,40	3,80	5,80	6,40	8,10	9,00	10,50	11,60	12,90	14,20	<b>5BA</b>
<b>4BA</b>	0,142	0,212	0,283	0,354	0,425	0,17	0,19	3,50	3,80	5,80	6,40	8,20	9,10	10,60	11,70	13,00	14,40	<b>4BA</b>
<b>3BA</b>	0,161	0,242	0,323	0,403	0,484	0,20	0,21	3,60	3,90	6,00	6,70	8,50	9,40	10,90	12,10	13,40	14,80	<b>3BA</b>
<b>2BA</b>	0,185	0,277	0,370	0,462	0,555	0,22	0,24	3,80	4,20	6,30	6,90	8,80	9,80	11,40	12,60	13,90	15,40	<b>2BA</b>
<b>1BA</b>	0,209	0,313	0,417	0,522	0,626	0,25	0,27	3,80	4,20	6,40	7,10	9,00	9,90	11,60	12,80	14,10	15,60	<b>1BA</b>
<b>0BA</b>	0,236	0,354	0,472	0,590	0,709	0,28	0,31	3,90	4,30	6,60	7,20	9,20	10,10	11,80	13,00	14,50	16,00	<b>0BA</b>
<b>BSC</b>																	<b>BSC</b>	
<b>3/16 - 32</b>	0,187	0,281	0,375	0,469	0,562	0,23	0,26	3,70	4,10	6,20	6,90	8,70	9,70	11,20	12,50	13,70	15,30	<b>3/16 - 32</b>
<b>1/4 - 26</b>	0,250	0,375	0,500	0,625	0,750	0,31	0,34	4,10	4,60	6,90	7,60	9,60	10,70	12,30	13,80	15,10	16,80	<b>1/4 - 26</b>
<b>5/16 - 26</b>	0,312	0,469	0,625	0,781	0,937	0,37	0,41	5,50	6,20	9,00	10,00	12,50	13,90	16,00	17,80	19,40	21,60	<b>5/16 - 26</b>
<b>3/8 - 26</b>	0,375	0,562	0,750	0,937	1,125	0,43	0,48	7,00	7,80	11,20	12,40	15,40	17,10	19,60	21,70	23,80	26,40	<b>3/8 - 26</b>
<b>7/16 - 26</b>	0,437	0,656	0,875	1,094	1,312	0,50	0,55	8,40	9,40	13,40	14,80	18,30	20,30	23,30	25,80	28,20	31,20	<b>7/16 - 26</b>
<b>1/2 - 26</b>	0,500	0,750	1,000	1,250	1,500	0,56	0,61	9,90	11,00	15,60	17,20	21,20	23,50	26,90	29,80	32,60	36,00	<b>1/2 - 26</b>
<b>9/16 - 26</b>	0,562	0,844	1,125	1,406	1,687	0,62	0,68	11,40	12,60	17,80	19,70	24,20	26,70	30,50	33,80	36,90	40,90	<b>9/16 - 26</b>
<b>5/8 - 26</b>	0,625	0,937	1,250	1,562	1,875	0,69	0,75	12,80	14,20	19,90	22,00	27,10	29,90	34,20	37,80	41,30	45,70	<b>5/8 - 26</b>
<b>3/4 - 26</b>	0,750	1,125	1,500	1,875	2,250	0,81	0,89	15,70	17,40	24,30	26,90	32,90	36,30	41,50	45,80	50,10	55,30	<b>3/4 - 26</b>
<b>1 - 24</b>	1,000	1,500	2,000	2,500	3,000	1,07	1,17	19,80	21,80	30,40	33,50	41,00	45,30	51,60	57,00	62,20	68,70	<b>1 - 24</b>

Nominal Thread Size	INSERT SPECIFICATIONS – FREE RUNNING – REDUCED DIAMETER																Nominal Thread Size	
	Q Nominal Length – installed					Free Coil Diameter		Number of Free Coils ± 1/4 coil counted 90° from Tang										
	1D	1,5D	2D	2,5D	3D	Min	Max	1D		1,5D		2D		2,5D		3D		
	inch	inch	inch	inch	inch	inch	inch	Min	Max	Min	Max	Min	Max	Min	Max	Min		Max
<b>8-UN</b>																	<b>8-UN</b>	
<b>1.1/8 - 8</b>	1,125	1,688	2,250	2,81	3,38	1,25	1,30	7,10	7,50	11,50	12,00	15,80	16,60	20,10	21,10	24,50	25,60	<b>1.1/8 - 8</b>
<b>1.1/4 - 8</b>	1,250	1,875	2,500	3,13	3,75	1,39	1,43	8,10	8,30	12,90	13,30	17,70	18,30	22,60	23,30	27,40	28,20	<b>1.1/4 - 8</b>
<b>1.3/8 - 8</b>	1,375	2,062	2,750	3,44	4,13	1,52	1,57	9,00	9,30	14,30	14,80	19,60	20,20	24,90	25,70	30,20	31,20	<b>1.3/8 - 8</b>
<b>1.1/2 - 8</b>	1,500	2,250	3,000	3,75	4,50	1,65	1,69	10,00	10,30	15,80	16,20	21,50	22,20	27,30	28,10	33,10	34,10	<b>1.1/2 - 8</b>
<b>1.5/8 - 8</b>	1,625	2,438	3,250	4,06	4,88	1,78	1,90	10,50	11,20	16,40	17,70	22,40	24,10	28,40	30,50	34,30	37,00	<b>1.5/8 - 8</b>
<b>1.3/4 - 8</b>	1,750	2,625	3,500	4,38	5,25	1,90	2,04	11,40	12,20	17,80	19,20	24,20	26,10	30,70	33,00	37,10	39,90	<b>1.3/4 - 8</b>
<b>1.7/8 - 8</b>	1,875	2,812	3,750	4,69	5,63	2,03	2,16	12,40	13,20	19,30	20,60	26,20	28,10	33,20	35,50	40,10	42,90	<b>1.7/8 - 8</b>
<b>2 - 8</b>	2,000	3,000	4,000	5,00	6,00	2,16	2,28	13,40	14,20	20,90	22,10	28,40	30,00	35,90	38,00	43,30	45,90	<b>2 - 8</b>

# powercoil®

wire thread insert system

 **BORDO®**  
INDUSTRIAL TOOLS

**Bordo Europe** VAT BE0825518302  
Industrieweg (BAA) 2, B9200, Dendermonde, Belgium  
**Telephone** +32 (0) 52 412110 **Facsimile** +32 (0) 52 410753  
**Email** info@bordoeurope.com **Web** www.bordoeurope.com

Part No. 9910-CAT0315.BE



9 3 2 6 5 1 8 1 6 8 6 0 7

Distributed by    Distribuiti da    Distribué par  
Vertrieb durch    Distribuido por